

# GYNOLASER

for vaginal tightening  
& urinary incontinence



LOTUS  GYNOLASER



## Unique feature

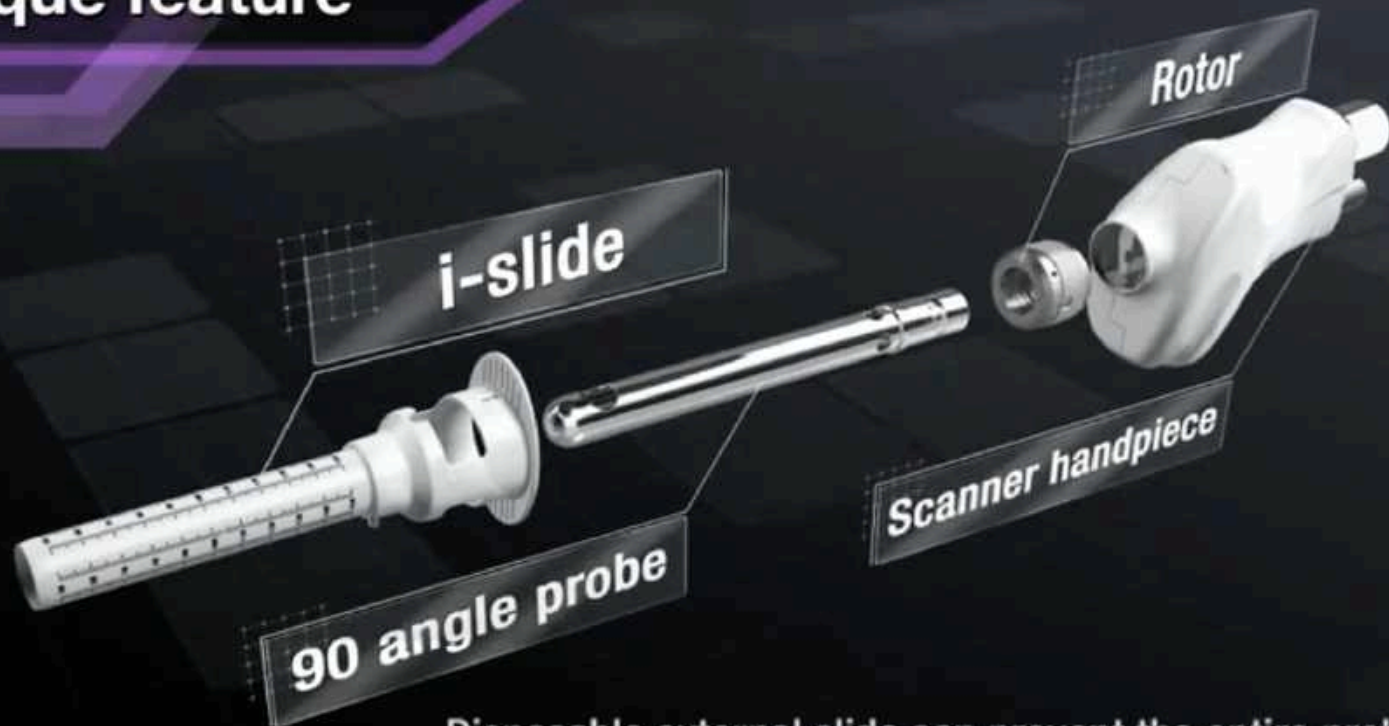

Disposable external slide can prevent the entire probe from sticking to the internal tissue

## Wide range of indications

Vaginal laxity

Stress incontinence

Recurrent thrush

Vaginal itchiness & burning

Dryness and loss of lubrication

Vaginal and vulvar pain or discomfort

Diminished sensation during intercourse

Dyspareunia (painful intercourse)



**Operating principal**

**90°**

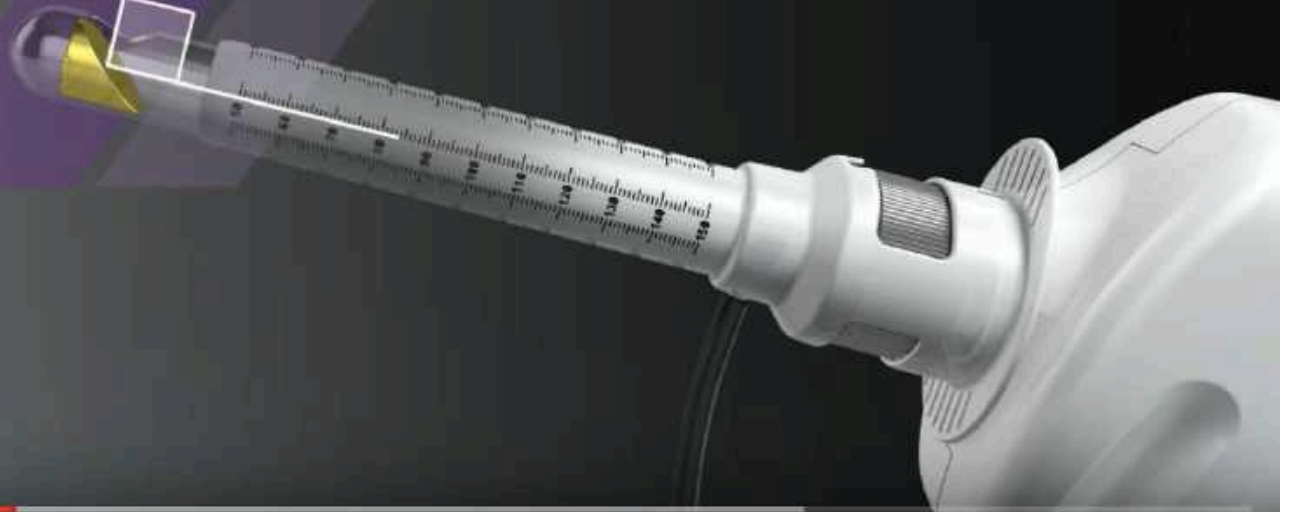

## Operating principal

### Benefit of Air flow

- ▶ Reduce the smoke interference to the laser beam
- ▶ Assist with turning the handset to avoid being over treated



## Operating principal

90 angle probe (Vaginal Tip) : Slide shape of tip which has 45 ° reflecting mirrors delivers CO<sub>2</sub> laser beam on wall of vagina as vertical

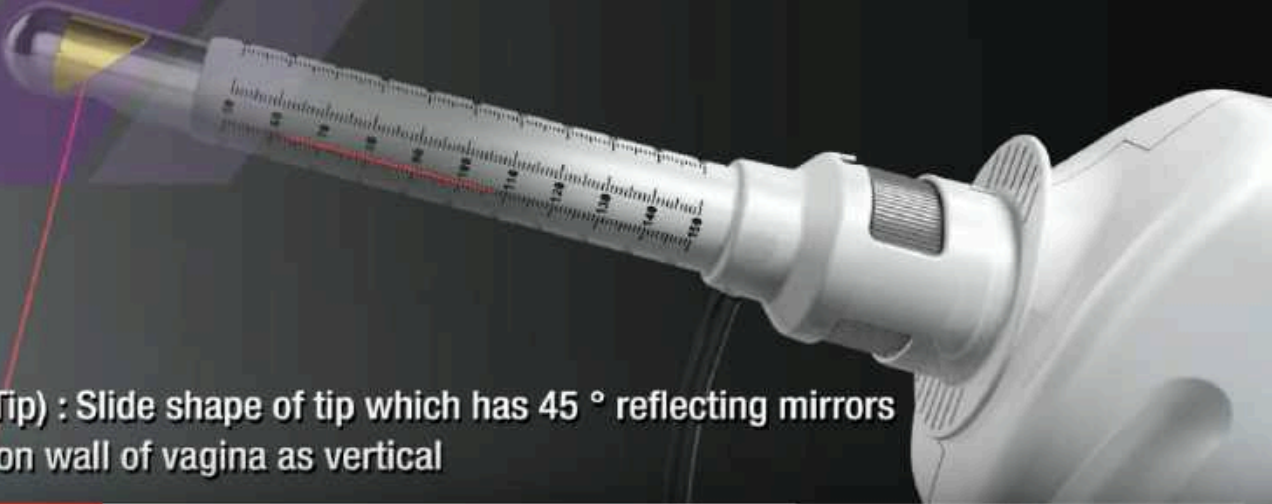

Vagina relaxation describes weakness and laxity of the vagina, caused by ageing, childbirth, vaginal injury, etc. Gynolaser is capable of improving this condition in a treatment called vaginal rejuvenation.



What is vagina relaxation?



## Treatment procedure



# Vaginal tightening operation

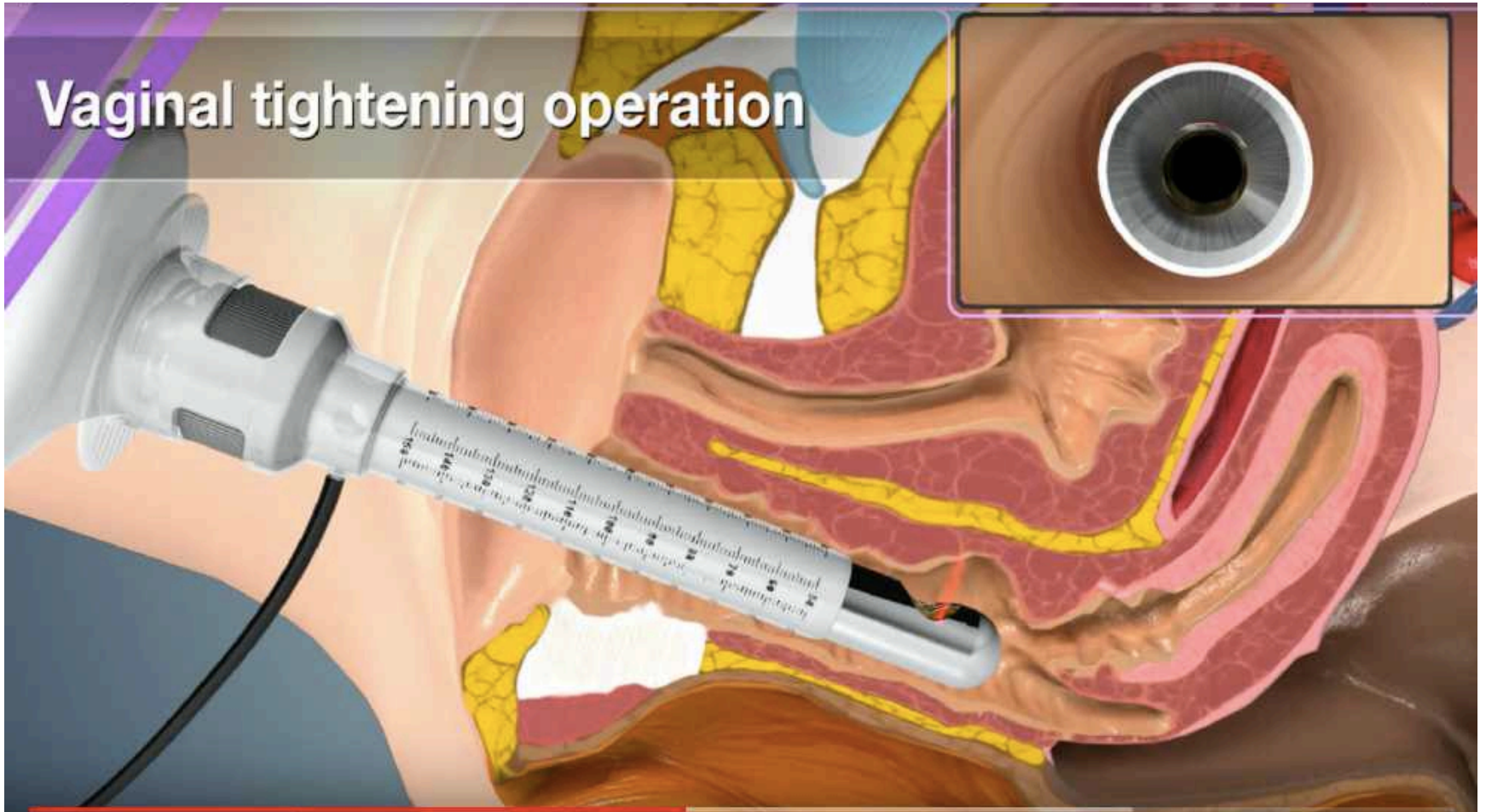

# Vaginal tightening operation

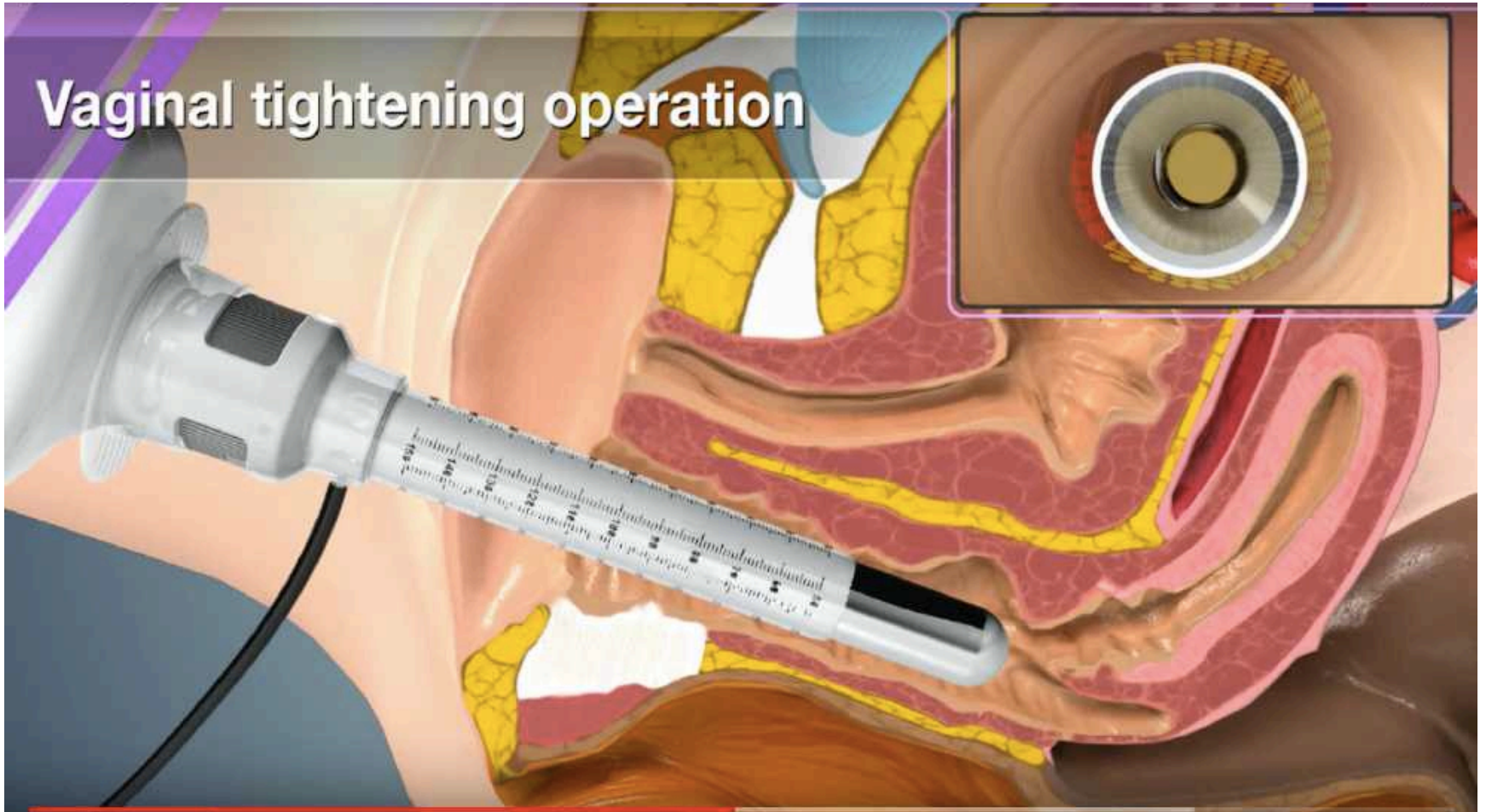

# Vaginal tightening operation

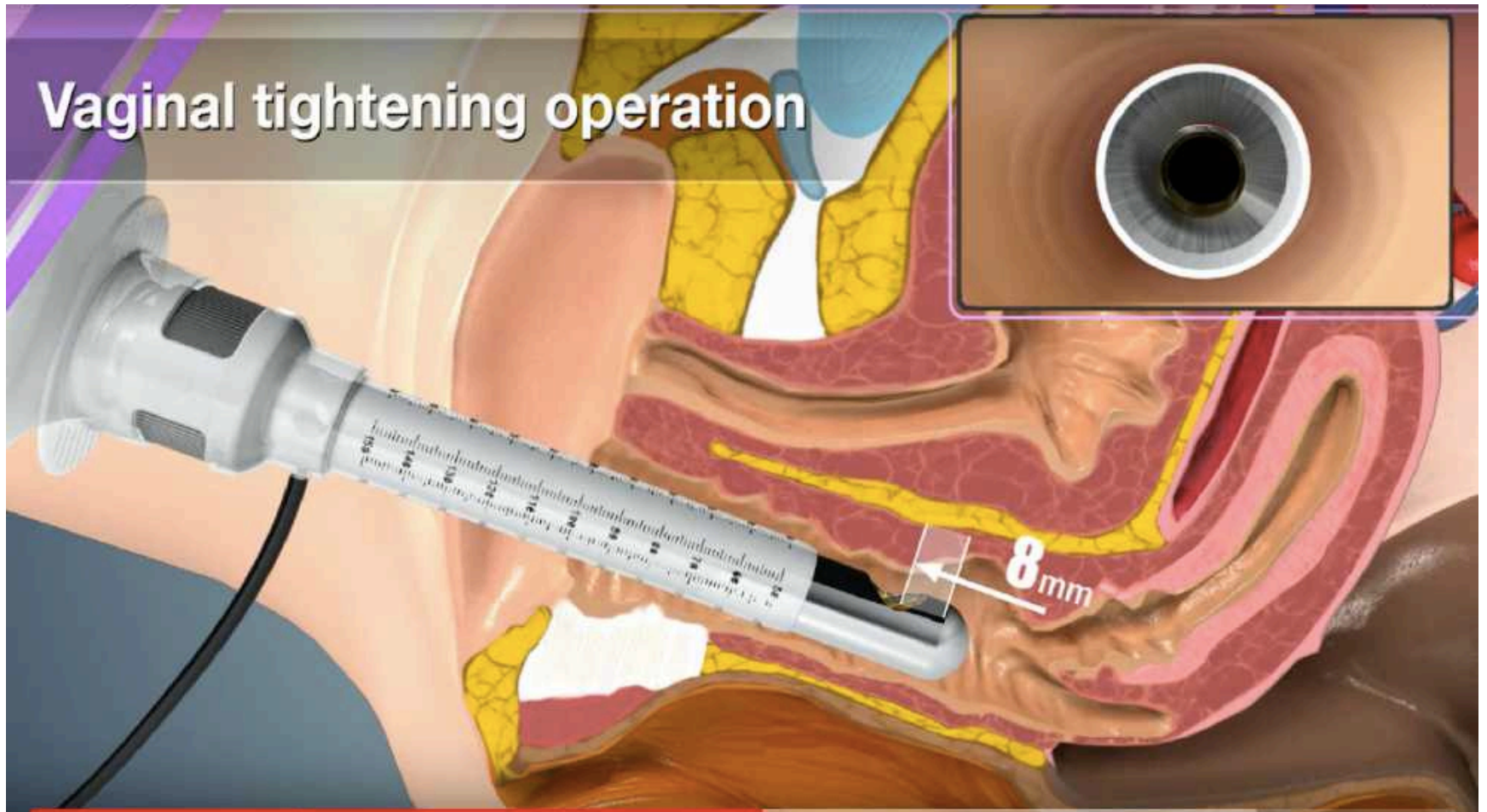

# Vaginal tightening operation

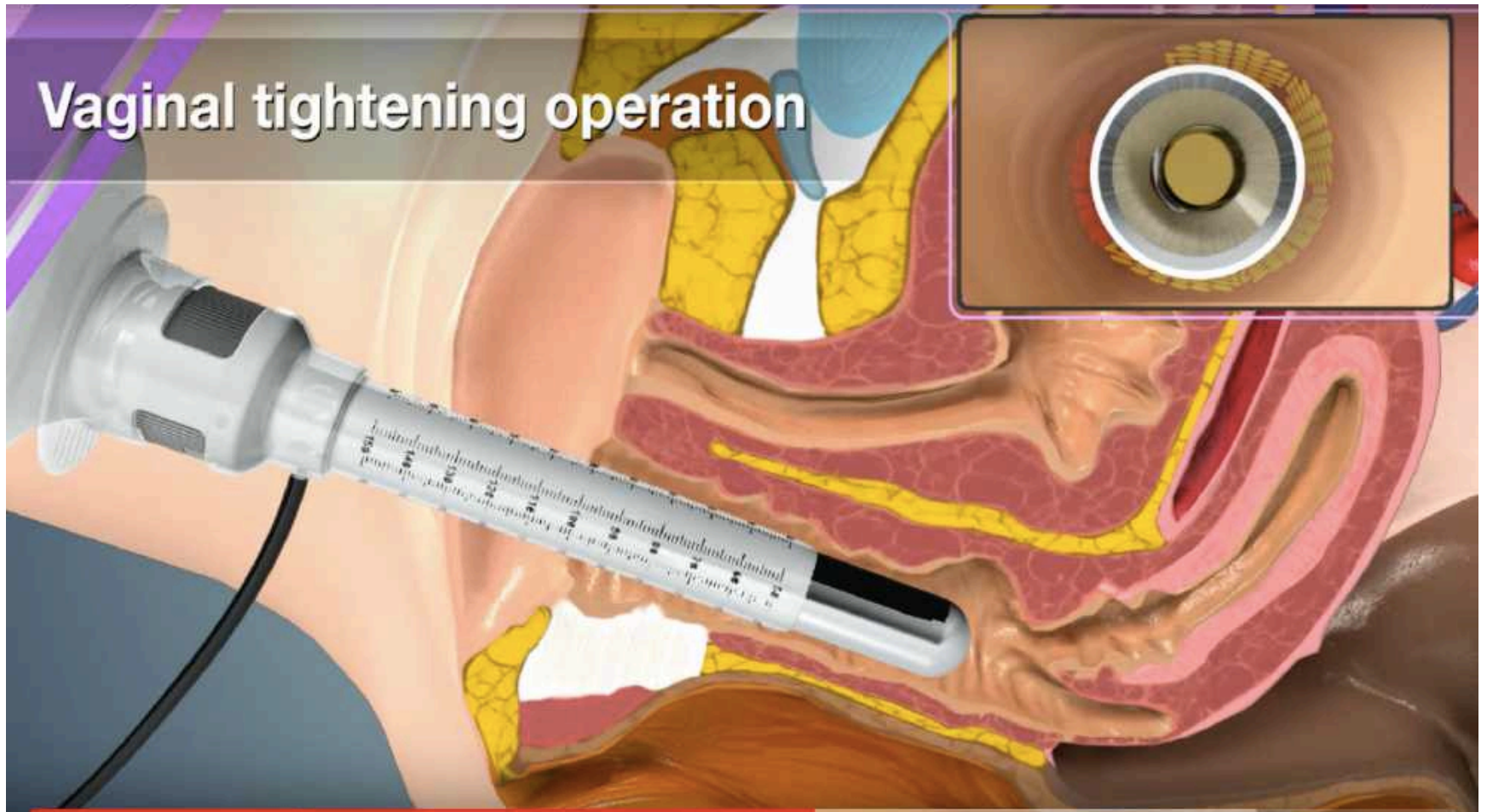

LOTUS  GYNOLASER

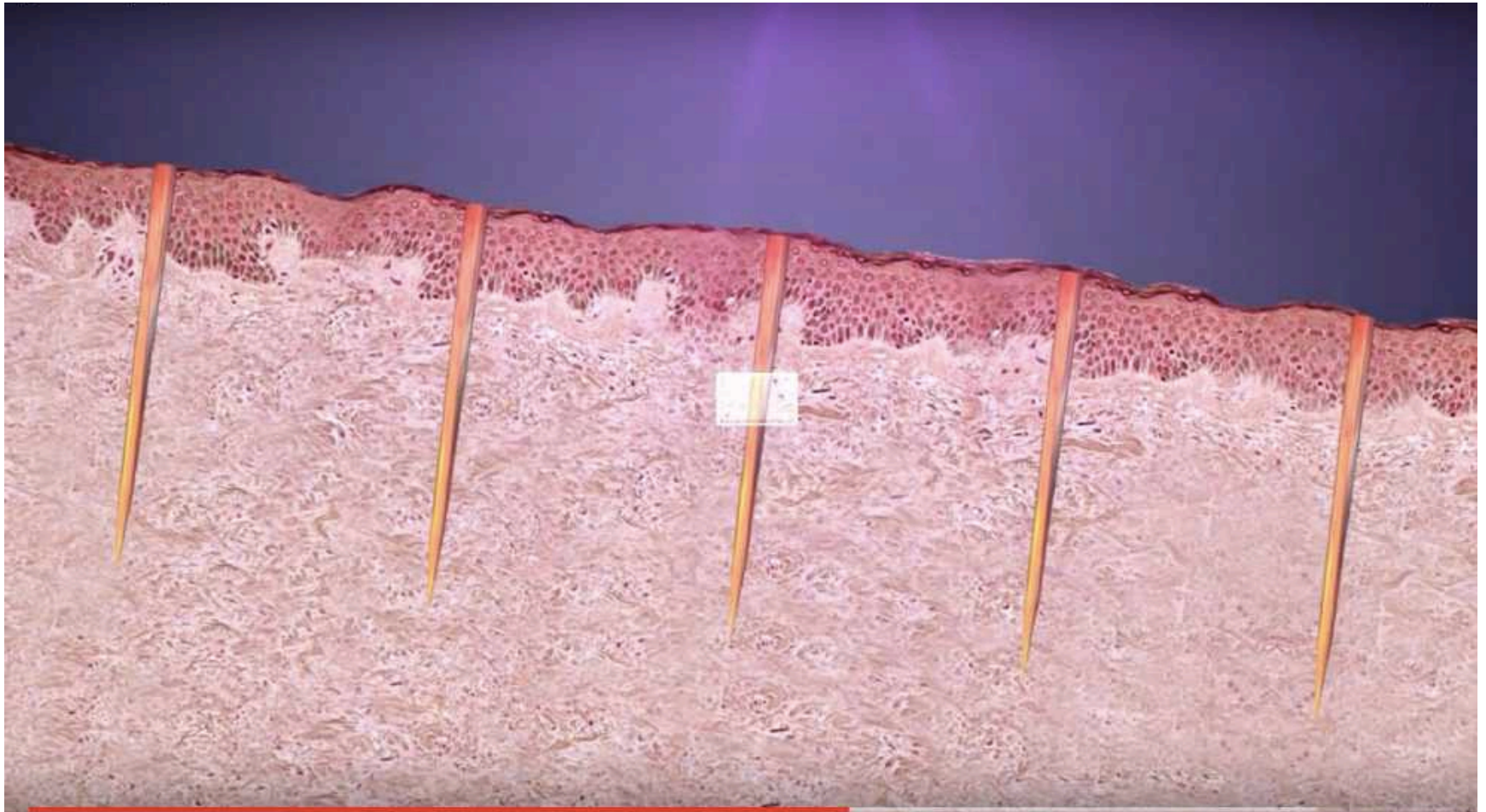

# LOTUS GYNOLASER

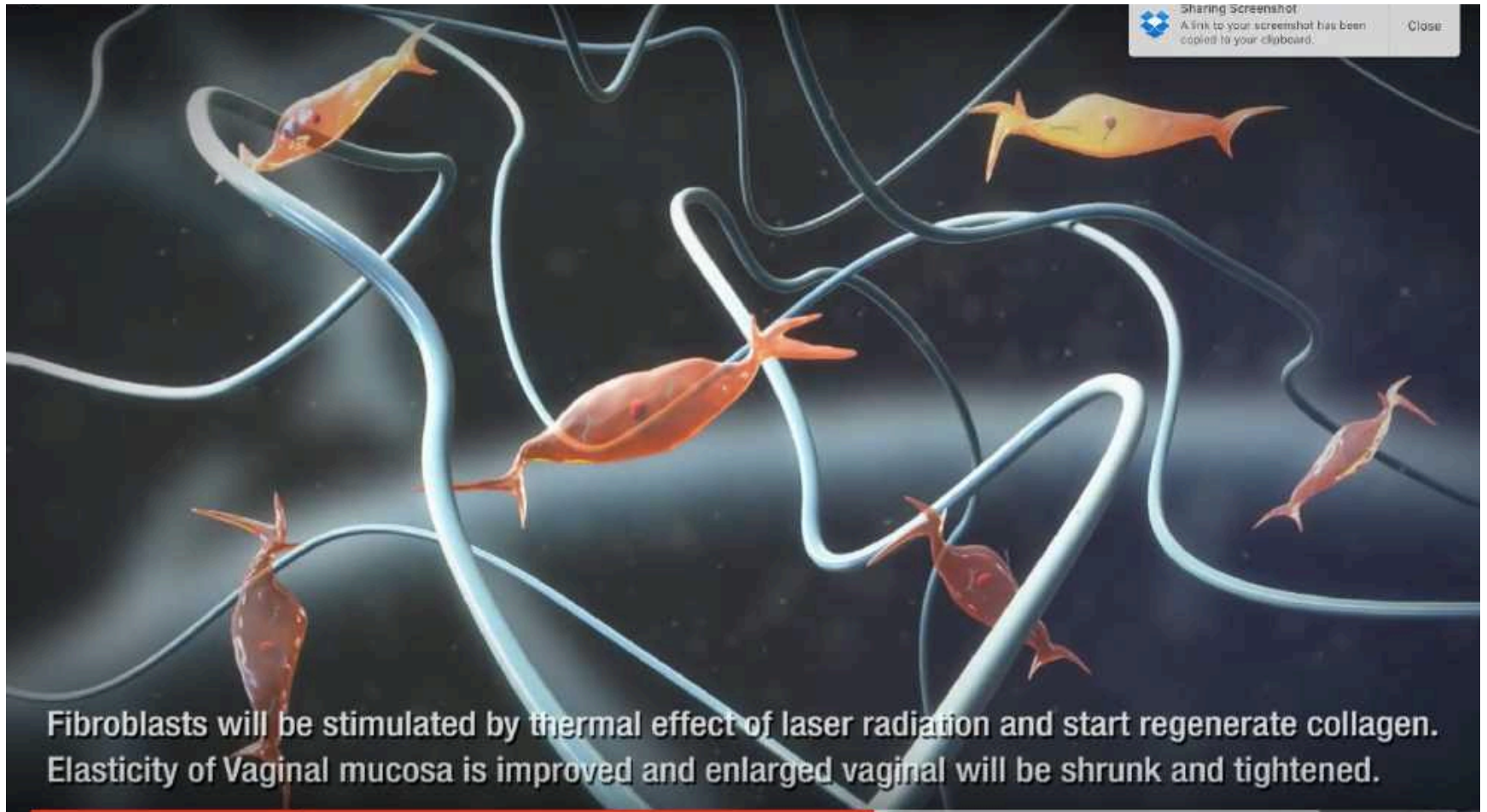

Sharing Screenshot  
A link to your screenshot has been copied to your clipboard. Close

Fibroblasts will be stimulated by thermal effect of laser radiation and start regenerate collagen. Elasticity of Vaginal mucosa is improved and enlarged vaginal will be shrunk and tightened.

LOTUS  GYNOLASER

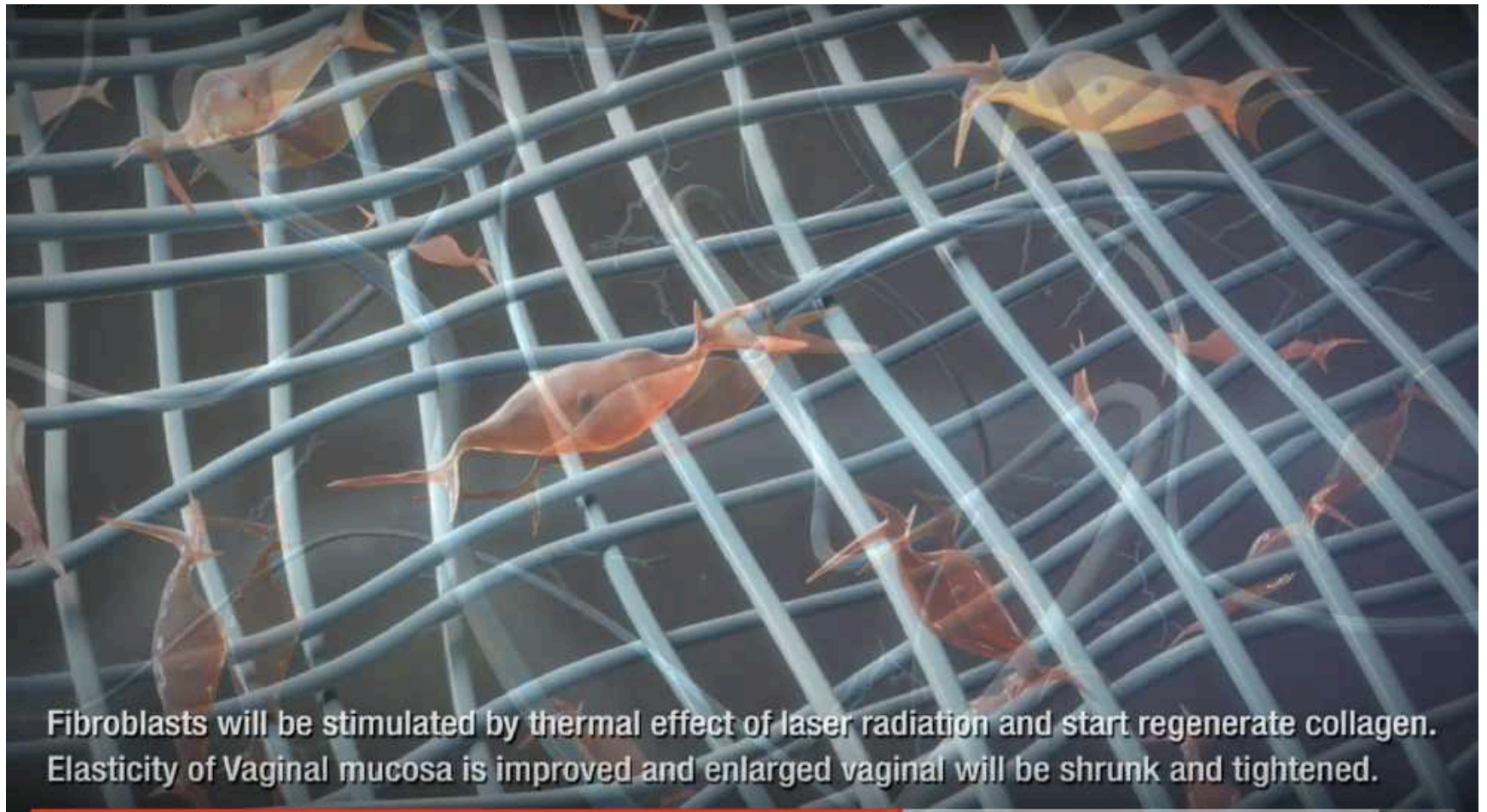

Fibroblasts will be stimulated by thermal effect of laser radiation and start regenerate collagen. Elasticity of Vaginal mucosa is improved and enlarged vaginal will be shrunk and tightened.



## Vulva and rejuvenation treatment



The vulva tip delivers fractionated CO<sub>2</sub> laser directly on the vulva area and helps to restore the appearance of the labia.

LOTUS  GYNOLASER

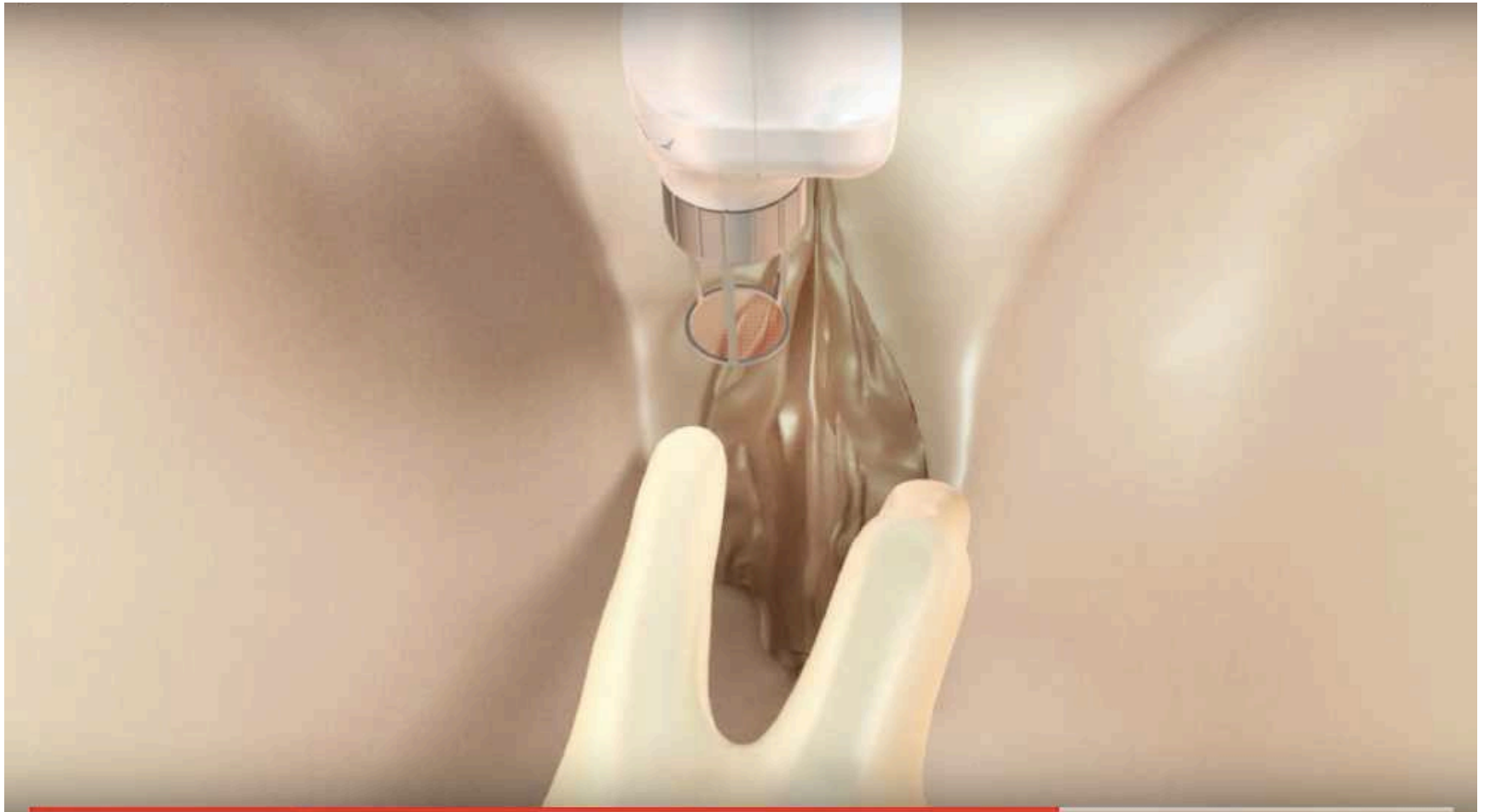

LOTUS  GYNOLASER

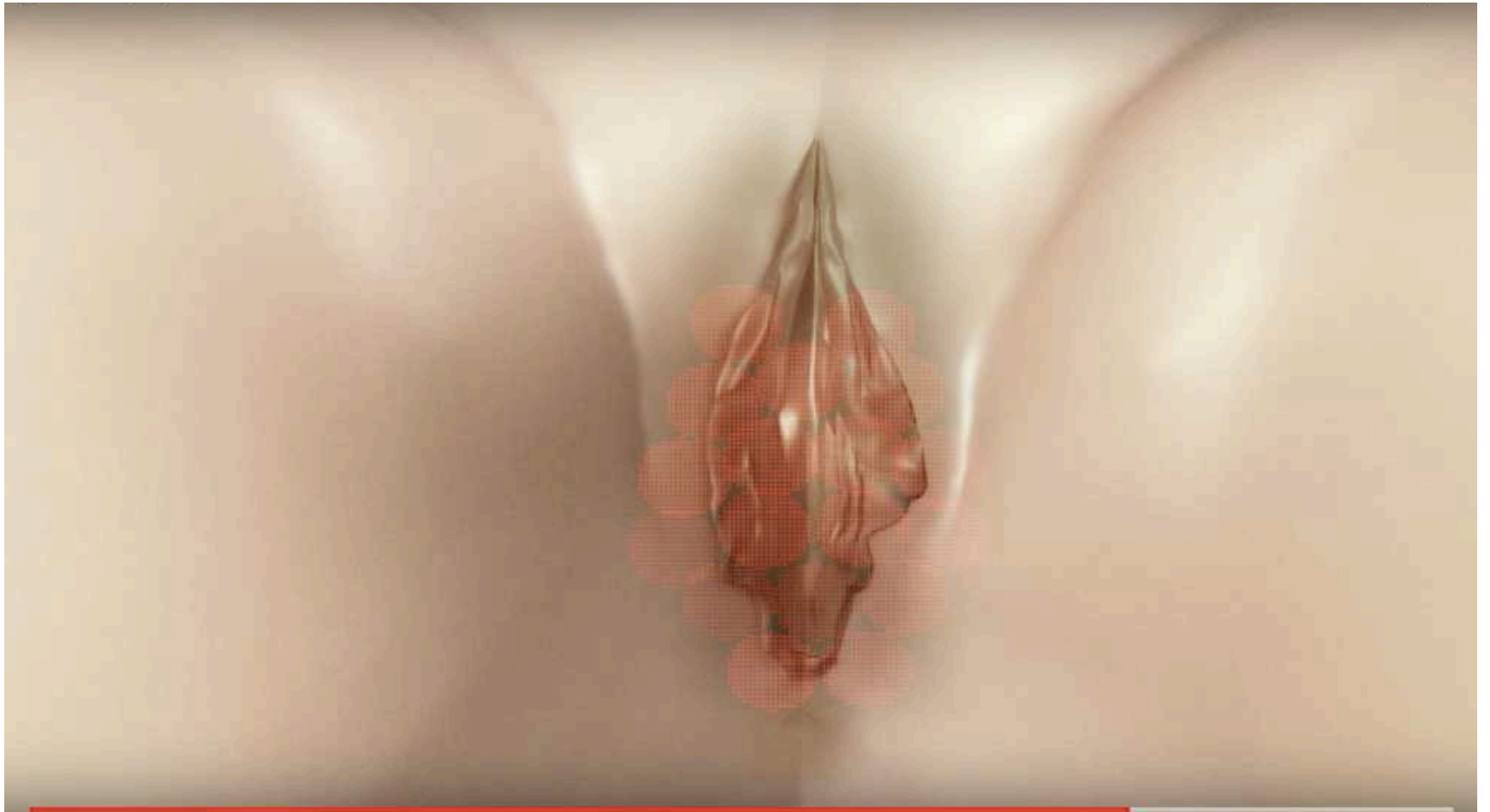

## Urinary incontinence



Urge urinary incontinence is caused by uncontrollable detrusor contractions. In order to stimulate the detrusor muscle using thermal laser stimulation, the urinary incontinence tip is used.

# Urinary incontinence

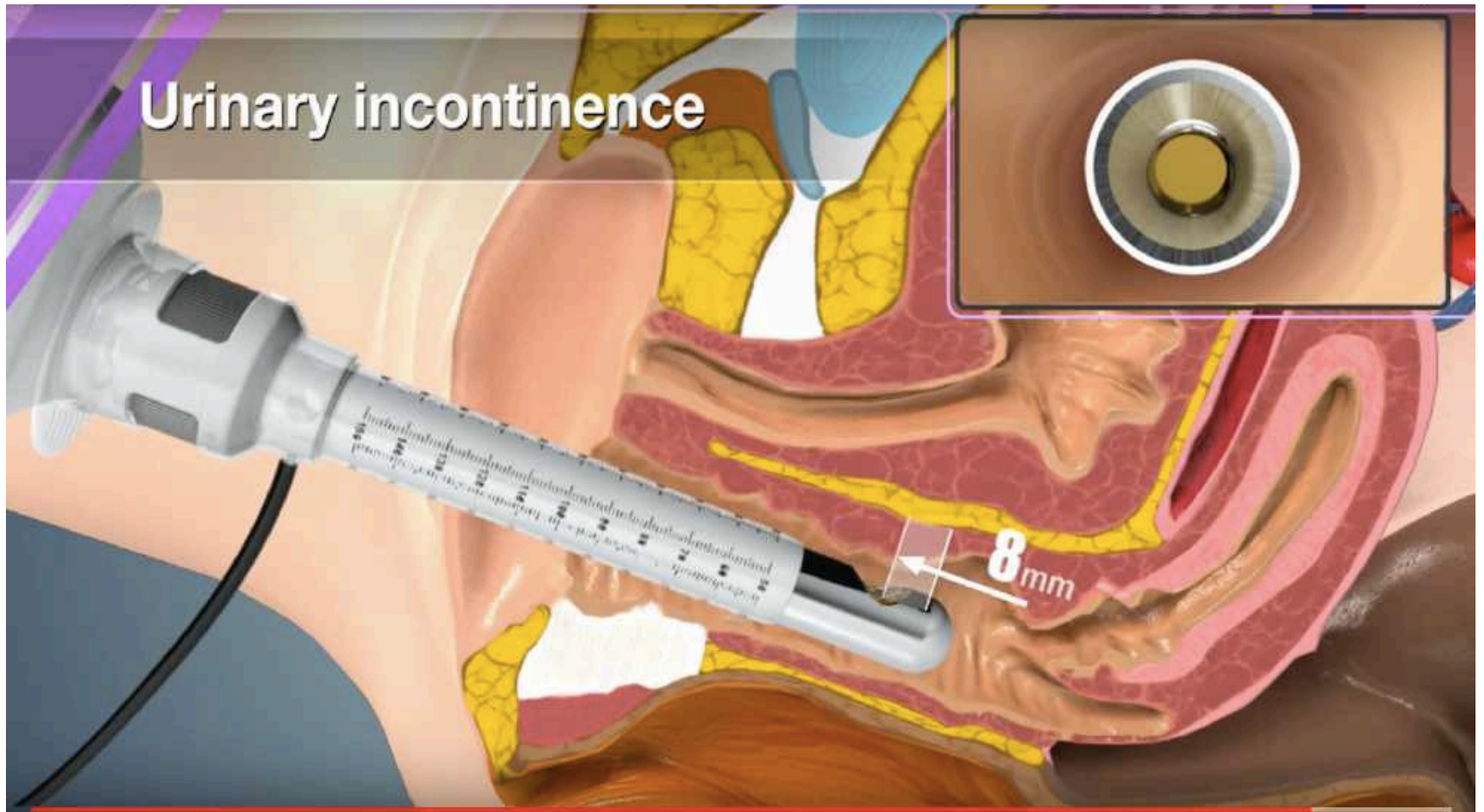

## Urinary incontinence

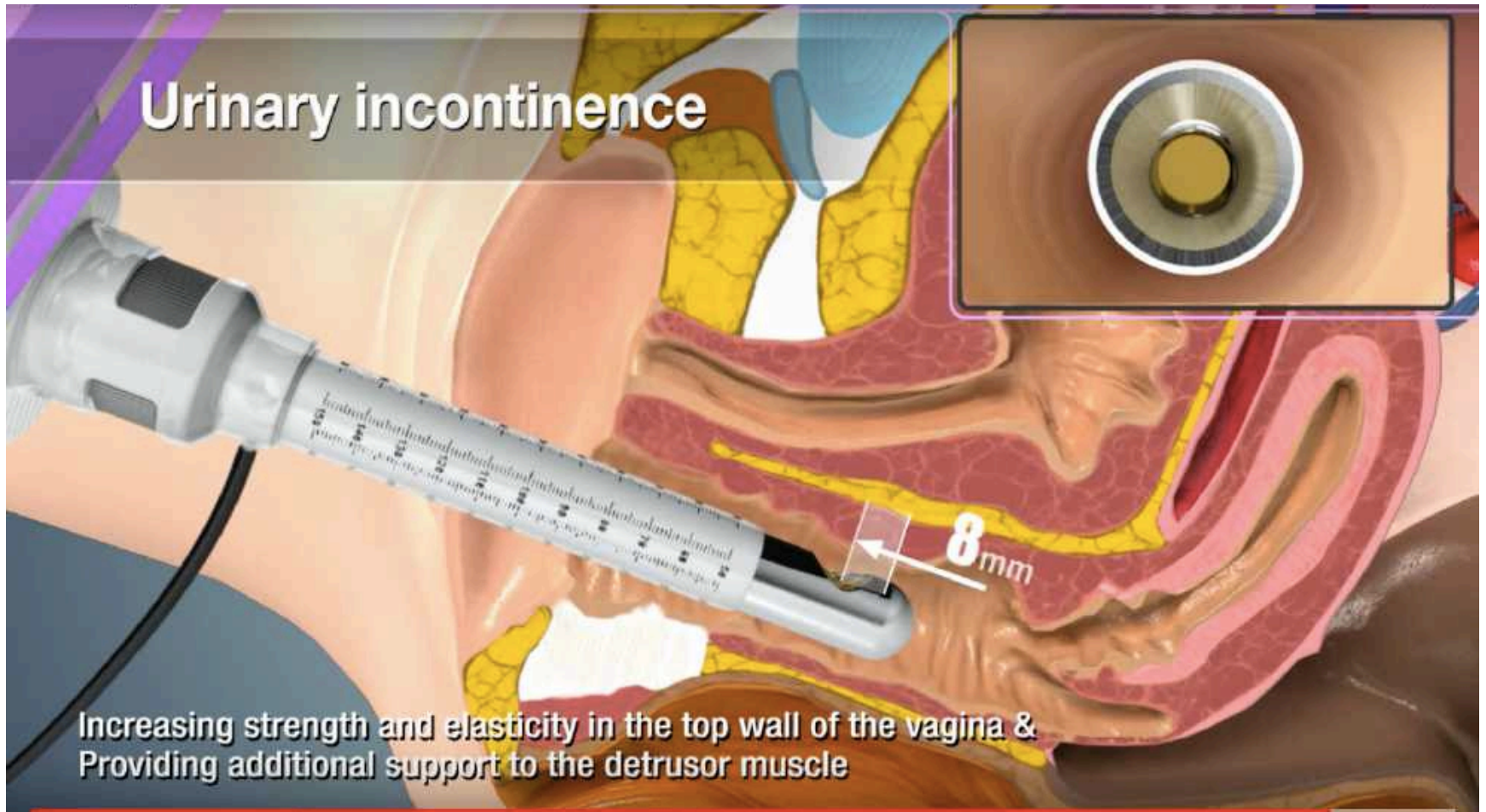

Increasing strength and elasticity in the top wall of the vagina &  
Providing additional support to the detrusor muscle

# GYNOLASER

for vaginal tightening  
& urinary incontinence



ilooda

