

High Power CO₂ Laser plus Micro-needle Fractional RF

FRAXIS^{DUO}TM

User Manual



120, Jangan-ro 458beon-gil, Jangan-gu, Suwon-si, Gyeonggi-do, 16200 Korea

www.ilooda.com

Made in KOREA

Any part of this user manual must not be modified, reproduced, or copied without prior permission of ILOODA CO., LTD. (Hereafter referred to as ILOODA)

ILOODA has the right to alter the technical specifications and/or configuration of the apparatus to enhance its performance, reliability or production capability in its discretion without any prior notification.

Exemptions

The information provided by ILOODA is correct and reliable.

However, ILOODA doesn't take any responsibility for the damage caused by using the equipment for different purposes other than original ones presented in this user manual.

ILOODA CO., LTD. (Manufacturing Company)

Address: 120, Jangan-ro 458beon-gil, Jangan-gu, Suwon-si, Gyeonggi-do, 16200 Korea

Tel: +82-31-278-4660 Fax: +82-31-278-4661

Website : www.ilooda.com , E-Mail : sales@ilooda.com

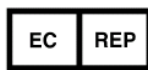

Obelis S.A

Address : Bd. General Wahis, 53 1030 Brussels, Belgium

Tel: +(32) 2. 732.59.54 Fax: +(32) 2.732.60.03

E-Mail : mail@obelis.net

Please check the related local regulations before using the equipment. The use of the apparatus may not be permitted if it is not in conformity with the related local law.



- Since the system includes industrial waste materials in the composition, an inappropriate disposal of materials can cause environmental pollution. Therefore, do not dispose of the waste along with common industrial or household waste.
- When disposing of the system in whole or in parts, comply with the related regulations of the standing legislation. For waste disposal related matters, consult with Ilooda Co.,Ltd. or authorized agent in each region.

How to Use This User Manual

- Purpose of This User Manual







The purpose of this manual is to make users be fully aware of the structure, installation, manipulation, operation, and maintenance of Secret System.

- Keeping of This User Manual

This manual must be kept together with the equipment or near the equipment so as that you can refer to it if necessary.

- Expressions Used in This User Manual

The expressions Caution, Note, and Warning as below are used in this manual.

Symbol	Description
	Warning, Consult Accompany Documents
	General mandatory action manual
	General prohibition indication
	Provision of additional information for assisting users.
	User Manual Reference
	Pushing prohibited



Please check the related local regulations before using the equipment.

The use of the apparatus may not be permitted if it is not in conformity with the related local law.



This equipment is a system applicable to the Laser and HF electrosurgical modes, which a system corresponding to an option may not be specified in this manual, and its performance and screen menu may be different depending on a handpiece option.

Qualification for Using FRAXIS DUO

It is strictly required that this equipment be used only by the doctor qualified for safety handling and use of laser apparatus and HF electrosurgical device.

Thus any persons concerned (nurses etc.) except for a doctor holding a license or a certificate on laser device must not use this equipment.

Only doctors are allowed to possess key of this equipment and please separate key from key switch of equipment when not in use to protect equipment from being used by other persons, not doctors.

It is recommended that all the relevant people (nurse etc.) including medical staffs complete the training on installation procedure, operating method and potential hazards of laser equipment, laser physics, and interactions of tissues and take the respective safety education program according to each country's regulation in addition to laser-related safety education.

It is also recommended that the doctor wanting to use the laser equipment obtain an approval required for using it from the relevant authorizing organization in the country.

Intended User profile.

Depending on IEC60601-1-6 standard for proper use of our equipment was described criteria who can use the device. Refer to following.

User	Doctors	Service engineer
Education	<ul style="list-style-type: none"> - User training - Basic Maintenance training 	<ul style="list-style-type: none"> - User training - Basic Maintenance Training - Professional Maintenance Training
Knowledge	<ul style="list-style-type: none"> - Experience with Laser treatment and High frequency surgical treatment. - Requirement medical knowledge. 	<ul style="list-style-type: none"> - Expertise for Laser and HF technology. - An information message comprehension required.

Table of Contents

Chapter 1	Introduction to FRAXIS DUO <ol style="list-style-type: none">1. Apparatus-verification data2. Supplied Items3. System introduction4. General information about FRAXIS DUO5. Essential for using equipment
Chapter 2	Safety Cautions <ol style="list-style-type: none">1. Instruction for Environmental safety2. Caution for safe use of equipment3. Labels4. Maintenance, cleaning and disposal
Chapter 3	Installation of Equipment <ol style="list-style-type: none">1. System overviews2. Description of Equipment3. Installation of Equipment
Chapter 4	Use of Equipment <ol style="list-style-type: none">1. Fractional Mode2. Normal Mode3. Auto Mode4. Manual Mode
Chapter 5	Technical Specification
Chapter 6	Output power characteristics
Chapter 7	Explanation on Messages <ol style="list-style-type: none">1. Error Message2. Warning Message3. Information Message

*** Attachment files.**

- Appendix 1. LABEL and Symbols**
- Appendix 2. Regular Safety inspection**
- Appendix 3. The revisions of User manual**

Chapter 1. Introduction to FRAXIS DUO

1. Apparatus-verification data

1.1 Main Unit

- Product Name : CO2 Laser unit + HF Electrosurgical device System
- Model Name : FRX-C2
- Trade Name : FRAXIS DUO
- Classification : Class IIb(MDD 93/42/EEC as amended according to the Directive 2007/47/EC)
- Intended use
 - CO2 LASER UNIT : CO2 Laser unit intended use to destroy tissue of patients for treatment of scarring.
 - HF electrosurgical UNIT : High frequency electrosurgical unit with bipolar and sterile electrode(Micro-needle type) are a device intended to using for thermal coagulation to the tissue by using high frequency for treatment of scarring.

1.2 Accessories

- Product Name : Sterile Electrosurgical electrode(Micro-needle electrodes)
- Model Name : MTR-AC-16, MTR-AC-25, MTR-AC-10, MTR-AC-C10

2. Supplied ITEMS

The followings are components(accessories) comprised of this equipment

- Main unit : Combination type devices(CO2 Laser + HF electrosurgical devices)
- Components
 - LASER Handpieces(included articulated arm)
 - HF electrosurgical Handpiece(Bipolar type)
 - Disposable HF electrosurgical electrodes(Micro-needle tip type)
- Accessories
 - Power cable(Common accessories)
 - Foot switch(Common accessories)
 - Key switch(Common accessories)
 - Goggles for operator and Goggles for patients(Laser accessories)
 - Remote interlock connector(Laser accessories)
 - HF handpiece Holder + Cable Holder(HF electrosurgical accessories)
 - User manual



NOTE

Some micro-needle electrodes is optional

3. System introduction

FRAXIS DUO is a combination of CO2 laser operator and electric operator.

It uses CO2 laser with 10,600nm wavelength to divide many micro laser beams into parts for irradiation on skin tissues.

Bipolar hand piece, a major function of high frequency operator, creates a path for new drug delivery by directly passing 16 / 25 thin and precise needles with thickness of 25mm through the skin layer and dermis. Operation is done by supplying RF energy to the penetrated needle.















CAUTION

Please do not use a combination of the Laser treatment and HF electrosurgical treatment.

4. General information about FRAXIS DUO

- Type of protection against electric shock: Class I Equipment
- Degree of protection against electric shock
 - Laser applied part : Type B Applied part
 - HF applied part : Type BF Applied part
- Class 4 laser equipment of IEC60825-1 (Invisible laser radiation)
- Degree of protection against the ingress of water
 - Main unit : IPX0
 - Foot switch : IP68
- Equipment not suitable for use in the presence of a flammable anesthetic mixture with air or with oxygen or nitrous oxide.
- HF electrosurgical electrode(Micro-needle types)
 - : E.O gas sterilization, Disposable(Expiration date : 3years)
- Operation Condition
 - Operation Temperature : Recommended within 0°C ~ 40°C
 - Relative Humidity : 10% ~ 75%
 - Atmospheric Pressure : 700 ~ 1060 hPa
 - Maximum Relative Humidity : 10% ~ 80%
- Storage and Transportation
 - Temperature Condition : 0°C ~ 60°C
 - Relative Humidity : 10% ~ 90%
 - Atmospheric Pressure : 700 ~ 1060 hPa
 - Maximum Relative Humidity : 10% ~ 90%

- Explanation of symbols

SN		
Serial Number	Lot number	Date of Manufacture
		
Caution, consult accompanying documents	Manufacturer	Authorized Representative in the European Community
REF		
Reference No.	Type B applied part (Laser applied part)	Type BF applied part (HF applied part)
		
Irradiation	Emergency Laser Emission Stop Switch	Foot Switch(IP68)
		
Alternating current	Power On/OFF	Interlock

5. Essentials for Using Equipment

The laser system is a medical treatment device that may only be used for its intended dermatological treatment purposes.



FRAXIS DUO should be protected against unauthorized use



The use of mobile telephones or similar devices is not permitted in the same room during operation of the laser.



Due to a possible risk of interference through electromagnetic radiation during operation, individuals with pace makers should not be present in the same room. Pregnant women should also leave the room.



Like any highly-effective medical device, demands special expertise and care in its handling and use. FRAXIS DUO may only be operated by physicians who have been trained to use the device properly in accordance with the user manual and who are familiar with its therapeutic effects and possible dangers.

**CAUTION**

- Please do not use a combination of the Laser treatment and HF electrosurgical treatment.
- No modification of this equipment is allowed.

The following instructions are the essential guidelines to be surely considered before using the equipment. In case that you don't observe them, the critical damage like the performance degradation of the equipment can be brought about.



- Don't operate the equipment differently from user manual on the purpose of practitioner and never use the equipment from different other purpose than original purpose.
- Never operate the equipment by non-authorized person without supervision from experienced expert
- Patient and operator (doctor) should not carry the metallic materials such as rings, watches, necklaces etc.
- Make sure to turn off equipment and pullout the key not to be operated by others when it is not used or even an operator(doctor) leaves for a moment.
- Never disassemble the equipment. The disassembly of the equipment can be carried out only by an authorized repair person of the manufacturer. It is impossible for the equipment to conduct the laser treatment in a situation when it is disassembled.

5.1 Installation of Equipment

**NOTE**

Please refer to "Chapter 3. Installation equipment" for installation instructions.

- The equipment must be installed and used only in a safe treatment room of hospital.
- The use of the equipment in other places (i.e. skin care shop, other treatment place etc.) except hospitals is strictly prohibited.
- Only authorized person can operate, manage and repair the equipment.
- The equipment should be moved and installed only in a state of turning-off and placed in a safety flat space.



This equipment has been tested and found to comply with the limits for medical devices in IEC/EN 60601-1-2. These limits are designed to provide reasonable protection against harmful interference in a typical medical installation.

This equipment generates, uses and can radiate radio frequency energy and, if not installed and used in accordance with the instructions, may cause harmful interference to other devices in the vicinity. However, there is no guarantee that interference will not occur in a particular installation.

If this equipment does cause harmful interference to other devices, which can be determined by turning the equipment off and on, the user is encouraged to try to correct the interference by one or more of the following measures



WARNING

To avoid risk of electric shock, this equipment must only be connected to a supply main with protective earth.



Not to position Equipment to make it difficult to operate the disconnection device. Install the equipment at least a 100mm distance from the wall.

5.2 Contraindications & Cautions for patients

5.2.1 Contraindications

Contraindications with regard to using this system for treatment of skin disease has yet to be known. But the patient who previously experienced adverse effect with treatment shall be classified as potential treatment patient through preliminary examination.

Careful attention or limitation shall be given during treatment of those described below.

1) Common Contraindications

- The pregnant women
- Breast feeding person
- For patients with cardiac pacemaker or other active implants.
- Within 2~3 months after BOTOX or filler treatment.
- Patient with unknown skin disease
- Patient who has very thin skin after many laser(ablative) treatments
- Sensitive patient with hot sensation

2) Laser treatment Contraindications

- Patient who has sensitive to the light or takes photoactive medicine.
- Patients suffering shingles recently

3) High frequency treatment Contraindications

- Implanted patients to the face with gold thread lifting.



WARNING

Use surgery with caution in the presence of internal or external devices such as pacemakers or pulse generators. Interference produced by the use of device can cause devices such as pacemakers to enter an asynchronous mode or can block the pacemaker effect entirely. Consult the device manufacturer or hospital Cardiology Department for further information when use of electrosurgical appliances is planned for patients with cardiac pacemakers or other implantable devices.

5.2.2 Caution

Make sure to give the treatment only to the patient in accordance with the purpose of this equipment after the doctor's prior diagnosis. The treatment to the patient with other lesion, not with the originally targeted one without the doctor's prior diagnosis is strictly prohibited. Before treatment, make sure to check the patient's skin state and sterilize the region to be treated so as that there are no foreign substances.

Before treatment, remind a patient of the cautions before, during, and after treatment and notify the possibility of occurrence of unintended abnormal symptoms to him or her.



NOTE

Please explain the contents of the following patients after treatment.

- Please avoid being exposed to water or sunlight for extended time till treatment part has been completely restored and notify how to care treated part.
- Hyper-pigmentation (excessive deposit of pigment on treated part) or Hypo-pigmentation (insufficient deport of pigment on treated part) may occur which is temporary symptom requiring no particular treatment.
- Notify to see doctor when experiencing flushing, pricking or any abnormality on or around treated part.

5.3 Setting for Output

Set output considering a patient's condition and parameter values before setting it

Place hand pieces at a safe place when setting its output. (Hand piece holder)

When adjusting a setting value, start with a small value, and increase the usage and strength gradually until the desired result is produced



- Avoid by all the safety related-cautions stated in this manual
- Place the hand-piece in designated position(hand piece holder).
- Check the value of screen first when you set the output value (intensity, RF, depth etc) according to the operational parameter.
- Use the equipment only onto the skin surface in which there are no infection and other damage.

5.4 Additional information of each functions

5.4.1 Laser part

1) Eye Protection

All of the persons around the laser equipment in use (doctor, patient, nurse and other supporting staffs) must wear the appropriate eye protection tools.

Never take a direct look at the laser tip.



Avoid eye exposure to direct radiation.

To protect eyes, shall wear the goggles specially manufactured to be compatible with specific wavelength.

Goggles by wavelength shall meet the following safety requirements at least

Eye Guard & Goggle

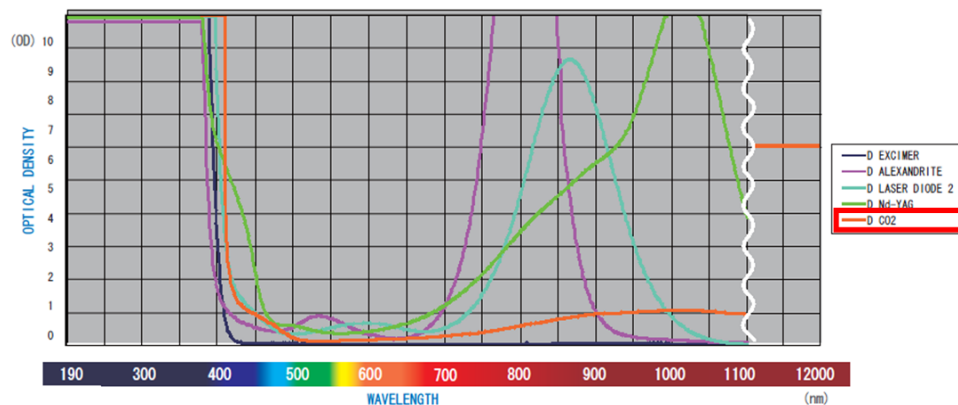

Goggles for patients



YL-800W1

- Color of eyecup / white
- Detachable and adjustable rubber strap
- Nose bridge / M
(Exchangeable S, M and XL bridges are included)
- Safety Eyeguard comes with softcase.

☞ DIR 180-315 D L8 + IR L4
DIR >315-1400 D L5 + IR L7
D >1400-10600 D L3

5.4.2 HF electrosurgical part

1) Sterilization HF electrosurgical electrodes(Micro-needle types)



- Be sure to check the sterilized condition of micro-needle electrodes to be used with the hand piece.
- Do not use needle electrodes that the sterilized packaging is damaged (torn, contaminated etc.), or there is no sterilized packaging.
- After looking a label printed on the sterilized wrapping paper carefully and checking its sterilized date, expiration date etc. surely, use only the needle electrodes decided that there is nothing wrong by checking whether the sterilized condition remains intact.
- Needle electrodes are disposable, which can be used only for a patient once a day, and a needle electrode opened once must not be reused.

Do not treat several people with a Micro-needle electrode, and do not use it for several terms or times.

Chapter 2. Safety Cautions

1. Instruction for Environmental safety

1.1 Electrical Hazard

All the users of the equipment should read and observe the following cautions for electrical safety, or electric shocks may take place.

One should not touch any part of equipment other than the system operation part.

When doing routines such as connecting or disconnecting the Laser Connector, please make sure to unplug or power-off the system.

When system is capable of causing physical injuries to either patients or users then the system operation can be stopped by pressing the emergency stop button. Emergency stop button is located on the front side of the handle and the pressing motion will stop the system operation.



- Make sure to use the laser system only in a place where there is electric installation, obeying the standards and regulations of each region.
- Do not use water or other liquid solvents when cleaning electrical parts. Prevent water or other liquid from spilling it on the laser system.
- Install with care not to fall down on electric wires and pipes or to entwine electric wires.
- Make sure to install and use the proper parts and accessories and do not use the different products from the accessories provided along with the equipment.
- Check the damage to the external appearance and electric wires of the equipment on a regular basis.
- Please contact manufacturer In case of replacing the parts.
- To avoid electric shock, the equipment must have ground connection.



- The operator shall not contact the parts(SIP/SOP) and the patient simultaneously.

1.2 Fire and Burn Hazard

All the users of the equipment should read and observe the following cautions for fire hazard, or fire may take place.

Long time use of equipment may cause overheat of equipment.

At the time of treatment, some materials or circumstances (materials made of cotton/wool containing sufficient oxygen) may ignite due to overheated equipment or emission of laser.

So, please be sure to take sufficient intervals to keep equipment from being overheated.

Also, please make solvent of adhesive and flammable solution used for cleaning and sterilizing fully vaporized before using. In case of solvent ingredient nearby the laser emitting part before treatment or equipment was cleaned with antiseptic solution, please be sure to take sufficient time until the equipment is fully dried before treatment.

In case equipment is overheated up to a certain degree, it is not operated with error message on the display. If error message is displayed, please turn off and pause the equipment for a while until the temperature falls.

Ingredient such as gas inside the treatment room may cause fire when laser is emitted.

Please make sure pay special attention to prevent influx of gases inside the treatment room



- Do not put the flammable or combustible materials or substances around the treatment room.
- Patient should not come into contact with earthed metal parts or parts with appreciable capacitance to earth.
- If you use alcohol to hand piece tip, wait up to the time when it is completely evaporated and dried before operating the system.
- Do not radiate the Energy to any part except for the part to be treated.
- Cut off the power immediately in case of fire.
- Do not fail to check the influx of gases inside the treatment room at all times.
- Avoid the hair, clothes, fabrics or other foreign substances that may work in reverse with the laser and absorb it.
- High temperatures produced in normal use of the laser equipment may ignite some materials (e.g., cotton wool when saturated with oxygen), and solvents of adhesives and flammable solutions used for cleaning and disinfecting should be allowed to evaporate before the laser equipment is used.
- Danger of ignition of endogenous gases. Please note at the time of use.

1.3 Electromagnetic compatibility_ Guidance and manufacturer's declaration

Guidance and manufacturer's declaration - electromagnetic emissions		
The FRAXIS DUO is intended for use in the electromagnetic environment specified below. The customer or the user of the FRAXIS DUO should assure that it is used in such an environment.		
Emission test	Compliance	Electromagnetic environment -guidance
RF Emissions CISPR 11	Group 1	The FRAXIS DUO uses RF energy only for its internal function. Therefore, its RF emissions are very low and are not likely to cause any interference in nearby electronic equipment
RF Emissions CISPR 11	Class A	The FRAXIS DUO is suitable for use in ail establishments, including domestic establishments and those directly connected to the public low-voltage power supply network that supplies buildings used for domestic purposes
Harmonic emissions IEC 61000-3-2	Class A	
Voltage fluctuations/ Flicker emissions IEC 61000-3-3	Complies	

Guidance and manufacturer's declaration - electromagnetic immunity			
The FRAXIS DUO is intended for use in the electromagnetic environment specified below. The customer or the user of the FRAXIS DUO should assure that it is used in such an environment.			
Immunity test	IEC 60601 Test level	Compliance level	Electromagnetic environment -guidance
Electrostatic discharge (ESD) IEC 61000-4-2	±6kV Contact ±8kV air	±6kV ±8kV	Floors should be wood, concrete or ceramic tile. If floors are covered with synthetic material, the relative humidity should be at least 30%.
Electrical fast transient/burst IEC 61000-4-4	±2kV for power supply lines ± 1kV for input/output lines	±2kV ±1kV	Mains power quality should be that of a typical commercial or hospital environment.
Surge IEC 61000-4-5	±1kV differential mode ±2kV common mode	±1kV ±2kV	Mains power quality should be that of a typical commercial or hospital environment.
Voltage dips, short interruptions and voltage variations on power supply input lines IEC 61000-4-11	<5% U_T (>95% dip in U_T) for 0.5cycle 40% U_T (60% dip in U_T) for 5 cycle 70% U_T (30% dip in U_T) for 25 cycle <5% U_T (<95% dip in U_T)for 5 s	No degradation of function	Mains power quality should be that of a typical commercial or hospital environment. If the user of the FRAXIS DUO image intensifier requires continued operation during power mains interruptions, it is recommended that the FRAXIS DUO image intensifier be powered from an uninterruptible power supply or a battery.
Power frequency (50/60Hz) magnetic field IEC 61000-4-8	3 A/m	3 A/m	Power frequency magnetic fields should be at levels characteristic of a typical location in a typical commercial or hospital environment.
NOTE U_T is the a.c. mains voltage prior to application of the test level.			

Guidance and manufacturer's declaration - electromagnetic immunity			
<p>The FRAXIS DUO is intended for use in the electromagnetic environment specified below. The customer or the user of the FRAXIS DUO should assure that it is used in such an environment.</p>			
<p>Conducted RF IEC 61000-4-6</p>	<p>3 Vrms 150 kHz to 80MHz</p>	<p>3 Vrms</p>	<p>Portable and mobile RF communications equipment should be used no closer to any part of the FRAXIS DUO, including cables, than the recommended separation distance calculated from the equation applicable to the frequency of the transmitter.</p> <p>Recommended separation distance</p> $d = \left[\frac{3,5}{V_1} \right] \sqrt{P}$ $d = \left[\frac{3,5}{E_1} \right] \sqrt{P} \quad 80 \text{ MHz to } 800 \text{ MHz}$ $d = \left[\frac{7}{E_1} \right] \sqrt{P} \quad 800 \text{ MHz to } 2,5 \text{ GHz}$ <p>where P is the maximum output power rating of the transmitter in watts (W) according to the transmitter manufacturer and d is the recommended separation distance in meters (m).</p> <p>Field strengths from fixed RF transmitters, as determined by an electromagnetic site survey, ^a should be less than the compliance level in each frequency range. ^b</p> <p>Interference may occur in the vicinity of equipment marked with the following symbol :</p> 
<p>Radiated RF IEC 61000-4-3</p>	<p>3 V/m 80 MHz to 2.5GHz</p>	<p>3 V/m</p>	
<p>NOTE 1) At 80MHz and 800MHz, the higher frequency range applies. NOTE 2) These guidelines may not apply in all situations. Electromagnetic propagation is affected by absorption and reflection from structures, objects and people.</p>			
<p>^a Field strengths from fixed transmitters, such as base stations for radio (cellular/cordless) telephones and land mobile radios, amateur radio, AM and FM radio broadcast and TV broadcast cannot be predicted theoretically with accuracy. To assess the electromagnetic environment due to fixed RF transmitters, an electromagnetic site survey should be considered. If the measured field strength in the location in which the FRAXIS DUO is used exceeds the applicable RF compliance level above, the FRAXIS DUO should be observed to verify normal operation. If abnormal performance is observed, additional measures may be necessary, such as re-orienting or relocating the FRAXIS DUO.</p> <p>^b Over the frequency range 150kHz to 80MHz, field strengths should be less than [V₁] V/m.</p>			

Recommended separation distances between portable and mobile RF communications equipment and the FRAXIS DUO			
The FRAXIS DUO is intended for use in an electromagnetic environment in which radiated RF disturbances are controlled. The customer or the user of the FRAXIS DUO can help prevent electromagnetic interference by maintaining a minimum distance between portable and mobile RF communications equipment (transmitters) and the FRAXIS DUO as recommended below, according to the maximum output power of the communications equipment.			
Rated maximum output power of Transmitter(W)	Separation distance according to frequency of transmitter(m)		
	150 kHz to 80 MHz $d = 1.2\sqrt{P}$	80 MHz to 800 MHz $d = 1.2\sqrt{P}$	800 MHz to 2,5 GHz $d = 2.3\sqrt{P}$
0.01	0.12	0.12	0.23
0.1	0.38	0.38	0.73
1	1.2	1.2	2.3
10	3.8	3.8	7.3
100	12	12	23
For transmitter rated at a maximum output power not listed above, the recommended separation distance d in meters (m) can be estimated using the equation applicable to the frequency of the transmitter, where P is the maximum output power rating of the transmitter in watts (W) according to the transmitter manufacturer. NOTE 1 At 80 MHz and 800MHz, the separation distance for the higher frequency range applies NOTE 2 These guidelines may not apply in all situations. Electromagnetic propagation is affected by absorption and reflection from structures, objects and people.			



Use of accessories, transducers, and cables other than those specified may result in degraded electromagnetic compatibility performance of this device!

2. Caution for safe Use of Equipment

2.1 Caution for product safety

The owner and user of the FRAXIS DUO are obliged to obey all of the equipment-related safety cautions. The following cautions related with the equipment must be observed.



- The equipment should be used only for defined purposes.
- Operate the equipment only when it is in normal condition (No error messages).
- Manage the user manual and all relevant documents in good condition and place them where the equipment is installed to be available at any time.
- Be sure to designate laser safety personnel in writing. Duties of safety personnel include the following.
 - Supervision of operation of laser equipment
 - Implementation of safe operation and taking all necessary measures by supporting owner/operator

2.2 Cautions to use LASER

Regulations specified in this manual aim to protect both operator and patient during the laser treatment. Laser equipment is differently classified by the degree of potential risk of equipment. FRAXIS DUO is classified as 4 Grade in laser risk grades in accordance with IEC60825-1(2007).



Improper use of equipment may cause a damage on the eyes due to direct or pulverized emission of laser beam. Laser beam may cause fire or explosion.



CAUTION

Use of controls or adjustments or performance of procedures other than those specified herein may result in hazardous radiation exposure

Make sure to designate the boundary of "laser area" that is allowed to exceed maximum permissible level of radioactivity during use of laser and mark the 'laser warning' indication. Install a warning light at the entrance and be sure to transmit a signal by light.



Everyone using laser shall read and keep the following prior cautions.

- Make sure to wear protective goggle with proper protective function to protect eyes from all sorts of laser beams of wavelengths.
- Be sure to put entire protective covers including front panel in their original places before turning on the switch of laser
- Abide by all the safety-related cautions stated in this manual.
- When you are to change the setting values, always check the displayed contents on the screen first to see if the application parameters are correctly set.
- Use the equipment only onto the skin surface in which there are no infection and other damage



- DO NOT press the foot switch before checking whether or not the location of handpiece is safe.
- Keep unnecessary personnel outside the treatment room while laser is in operation.

2.2.1 Optical Hazard.

Laser wavelength in the visible ray range carries the hazard that can damage to the retina unless you conform to the safety cautions.

All of the persons in a treatment room should wear the laser goggles protective against the laser wavelength radiated from this equipment



NOTE

Laser protective goggles.

To protect eyes sufficiently and properly, please make sure to wear protective goggle manufactured matching specific laser wavelength.

There are various different types of laser goggles. Wear the goggles made suitable for each wavelength (color).

Do not take a direct look at the tip from which the laser is radiated, even when you are wearing the laser goggles.



- All of the persons around the treatment must wear the eye protection tools (goggles and eye guards) and must not take a direct look at the laser tip or reflected ray. It may bring about permanent damage to eyes.
- The eye protective glasses for patient should be opaque and not pass any light through them. In occurrence of an accidental radiation of laser, the patient goggles should not reflect light or not conduct heat.
- Use the patient eye guards provided with this equipment.
- When the laser light is visible to your sight, stop using the laser equipment immediately and check if the protective glasses are damaged or inappropriate.

Every goggle as per wavelength at least must follow below safety standard.

- OD 5+ @ 190-360nm
- OD 5+ @ 10,600 nm

1) Management of Protective Goggles

Make sure to check the damage and the protective function against laser beam of protective goggles regularly or whenever it is doubtful in accordance with manufacturer's instruction.



- Goggles other than goggles provided with this equipment are not allowed.
- In case goggle is damaged, make sure to ask the dealer and get a new goggles and please do not purchase and use other goggles arbitrarily.

2) NOHD

NOHD (Laser Safety Distance) means the minimum range that luminance and exposure of radiation drops at less than allowed proper maximum level under ideal conditions.

	P _o =10W	P _o =11W
Exposed site : less 0.1m ²	27m	29m
Exposed site : one more 0.1m ²	88m	93m

3) Risk of Laser Release

Laser beam from handpiece may cause damage on the eyesight as well as serious burn on skin and other organs. It is essential to follow proper procedure of handling when using handpiece. While wearing protective goggle, please be sure to recognize the risk of laser beam even if it is invisible.

Put the handpiece tip downward all the time and keep the handpiece in the handpiece holder. When the treatment comes to a halt or stops, put the system into the standby mode or turn off the system, and make sure to take the laser goggles off only after the shutdown of the system.

Post up a warning label for laser radiation on the outside of a treatment room and all the staffs of a hospital well-informed of the proper laser use protocol.



- DO NOT look at the laser beam directly regardless of types of beams
- DO NOT look at the laser discharge bay of handpiece directly even if your wearing a protective goggle

2.2.2 Smoke hazard

When Category 4 laser device is in operation, hazardous gas is mostly generated while tissue is vaporized and such smoke pillar contains virus particle having respiratory organ sized about $0.1\mu\text{m}$. So smoke pillar shall be removed from treatment environment

Wearing mask as part of the way to filter the smoke is not recommended

Local discharge ventilation system which is tightly contacted to laser source is recommended which includes portable smoke extractor using charcoal or HEPA filter ($0.1\mu\text{m}$ at least) with 99% or more extraction efficiency.



Smoke pillar generated during laser treatment may contain growing granular component of tissue and so the smoke shall be ventilated
Laser fume and/or plume may contain viable tissue particulates

2.3 Cautions to use HF

- Entire area of neutral electrode(optional) should be reliably attached to a suitably prepared and appropriate area of the patient's body as defined by the manufacturer.
- Patient should not come into contact with earthed metal parts or parts with appreciable capacitance to earth (e.g., operating table supports, etc.)
- Instructions stating, avoid skin-to-skin contact by insertion of dry gauze
- When high frequency surgical equipment and physiological monitoring equipment are used simultaneously on the same patient, place any monitoring electrodes as far as possible from the surgical electrodes.



NOTE

Do not use needles as monitoring electrodes during electrosurgical procedures. Inadvertent electrosurgical burns may result.

- The cables to surgical electrodes should be positioned in such a way that contact with the patient or other leads is avoided. Temporarily unused active electrodes should be stored so that they are isolated from the patient.
- Use the lowest output setting necessary to achieve the desired surgical effect.
- Pediatric applications and/or procedures performed on small anatomic structures may require reduced power settings. The higher the current flow, and the longer the current is applied, the greater the possibility of unintended thermal damage to tissue, especially during use on small structures.

- The use of flammable anesthetics or oxidizing gases such as nitrous oxide (N₂O) and oxygen should be avoided if a surgical procedure is carried out in the region of the thorax or the head, unless these agents are sucked away.
- Provide as much distance as possible between the electrosurgical generator and other electronic equipment (such as monitors). An activated electrosurgical generator may cause interference with them.
- To avoid incompatibility and unsafe operation, use suitable cables, accessories and active electrodes, including values for the highest allowed H.F. peak voltage.
- Avoid HF output settings where maximum output voltage may exceed rated accessory voltage.
- When using Bipolar mode, associated equipment and active accessories should be selected that have a voltage rating of 400V p-p or greater.



- Failure of the high frequency electrosurgical equipment could result in an unintended increase of output power
- Minor neuromuscular stimulation is possible when arcs between the ACTIVE ELECTRODE and tissue occur. The generator has been designed to minimize the possibility of neuromuscular stimulation.

2.3 Cautions on system use

2.3.1 Cautions before Use

- Make sure to read the instructions and use the equipment before using it.
- Make sure to use the equipment on a doctor's prescription.
- Do not connect the power on with a wet hand.
- Be careful not to spill water into the main body. It can cause the damage to the equipment and the fire and electric shock.
- Do not install the equipment in a watery, humid place. It can cause the damage to the equipment and the fire and electric shock.
Be careful not to make the power cord pressed by heavy weights or touched by sharp materials. The use of a damaged cord can cause fire or electric shock.
- Never use the equipment near flammables. It can cause the deformation of the main body, the failure in the system, and the fire.
- Make this machine used only a professionally trained person.
- Conduct a prior check on the manipulation of the system.
- Check the switches etc. and then confirm the correct operation.
- Connect all the cords accurately not to break away easily.

- When you use the equipment after a long interval, confirm if it operates normally and safely or not.
- Never disassemble or change the equipment by anybody except by an installation and repair technician. It can cause fire or electric shock.
- Check the proper output energy amounts before and during an electric surgical procedure.
- Only use the provided accessories. Don't use other accessories not from us.
- Do not use a product with damaged packaging.

**NOTE****Operating condition**

- Operating condition : within 10°C ~ 40°C
- Relative humidity : 30% ~ 75%
- Atmospheric pressure : 700 ~ 1060 hPa
- Max relative humidity : 10% ~ 90%

2.3.2 Cautions during Use

- Make sure to wear the operator's goggles and patient's eye guards.
- Remove all the interruptions around the equipment when it is used. Do not put papers or other materials on the top of the machine and block the vent.
- When the failure in the system takes place, stop using it, and turn off the power and then contact our customer service center.
- In case of a power outage, turn off the power immediately and put the controlling knob and switches back to the original position.
- Do not use the equipment near a patient monitor.
- Always check if there are some abnormalities on the patient and the equipment during use. If some abnormalities occur on the patient or the equipment, check the patient's safety and stop the equipment. When you confirm that the patient and the equipment have no problems after check-up, continue to use it again.
- Do not look at the laser light reflecting from a reflector or flashing directly at your eyes.
- In case of electrosurgical unit, please note the following.
 - Do not perform an electric surgical procedure if there is a combustible anesthetic.
 - Avoid operations at the places with rich oxygen and nitric oxides. These two types of gas may cause a fire and burns to patients.
 - If possible, cut off the oxygen supply before and during an electric surgical procedure.
 - Set power as low when applying or performing to a small-sized young child.
 - If high or lengthy power is applied, it may increase possibility to cause unintended damage to tissues.

2.3.3 Cautions after Use

- After use, put the control knob and switches back to the original position and turn off the power.
- Be careful not to give an excessive force to the connecting part of cords when you pull out the cords.
- Make sure to turn off the power and take out the key so that other people cannot operate the equipment.
- Do not pull the cord of the main body by force. It can cause the performance degradation of and the trouble with the machine.

3. Labeling

Refer to "Appendix 1. LABEL & Symbols " for shape and adhesion position of the labels attached to this equipment.

4. Maintenance, cleaning and disposal.

4.1 Maintenance

Perform regularly scheduled equipment inspections for safety of patients and users.



NOTE

Refer to " Appendix 2. Regular Safety inspection"

- In case of the trouble with machine, make sure to stop using it and contact the store you purchased from or the customer service center.
- Never open the machine and the controller.
- Do not give an impact to the main body. If there had been some impact on it, make sure to use the equipment after check-ups.

4.2 Storage

- Do not keep the equipment in a place where there is some slope, shaking, or possible impact. It can cause the performance degradation of the machine or the fire and electric shock.
- Do not keep the equipment in a place where chemicals are stored or some gas is generated.
- Do not keep the equipment in a place where temperature, air pressure, humidity, ventilation, sunlight, and air containing dust, salt and sulfur have a harmful influence on it.



Keep the equipment in a place far from water.

**NOTE**

Storage and transfer condition

- Temperature : Within 10°C ~ 60°C
- Relative humidity : 10% ~ 90%
- Atmospheric pressure : 700 ~ 1060 hPa
- Max relative humidity : 10% ~ 90%

4.3 Cleaning

1) Main body, Laser and HF electrosurgical hand-pieces

- Clean the main body and connector of hand piece by air to remove dirt.
- For the main body except connector area(Front, Back, LCD), scrub it by soft Cotton with alcohol on the caution not to be permeated liquid to the connector.

2) Laser guide(Scanner tip & Normal tip)

Wipe off Laser guide with ethanol or isopropanol (70-90%) soaked cotton cloth or swab for a minute or longer

3) Gyno Laser handpiece

- (1) Wipe off gyno laser Handpiece with 75% hydrogen peroxide soaked cotton cloth or swab for a over 12-30 minutes at 20 °C
- (2) High-temperature sterilization: steam or high temperature air
For steam sterilization 3-30 minutes



For a Gyno laser to be sterilized after cleaning.



- Non-flammable agents should be used for cleaning and disinfection wherever possible.
- Flammable agents used for cleaning or disinfecting, or as solvents of adhesives, should be allowed to evaporate before the application if HF surgery. There is a risk of pooling flammable solutions under the patient or in body depressions such as the umbilicus, and in body cavities such as the vagina. Any fluids pooled in these areas should be mopped up before HF surgical equipment is used. Attention should be called to the danger of ignition of endogenous gases.
Some materials, for example cotton, wool and gauze, when saturated with oxygen may be ignited by sparks produced in Normal Use of the HF surgical equipment.
- Clean and disinfect only instructed detergents and do not use other detergents.



- Use soft texture material(cotton, cotton swab) and do not use sharp material.
- Don't reuse disinfected materials(cotton, cotton swab).
- Don't scrub hard the machine.
- Have a caution not to be permeate disinfectant to the connector.
- Never apply the disinfectant to the equipment directly.
- Use the soft cotton when disinfect the electro of hand piece. If there is scratch on it, it might cause a problem with output of HF.
- Must turn off the equipment during cleaning, don't clean during operation.
- Use the equipment after disinfectant is completely dry.

4.4 Disposal



- Since the system includes industrial waste materials in the composition, an inappropriate disposal of materials can cause environmental pollution. Therefore, do not dispose of the waste along with common industrial or household waste.
- When disposing of the system in whole or in parts, comply with the related regulations of the standing legislation. For waste disposal related matters, consult with ILOODA Co., Ltd. or authorized agent in each region.
- When discard the electrode(Needle tip), must follow the rule of medical disposal in the country to prevent bio-contamination.



The HF electrosurgical electrode(Needle tip) is single use.
Do not re-use.
Please dispose of immediately after use.

Chapter 3. Installation of Equipment

1. System Configuration

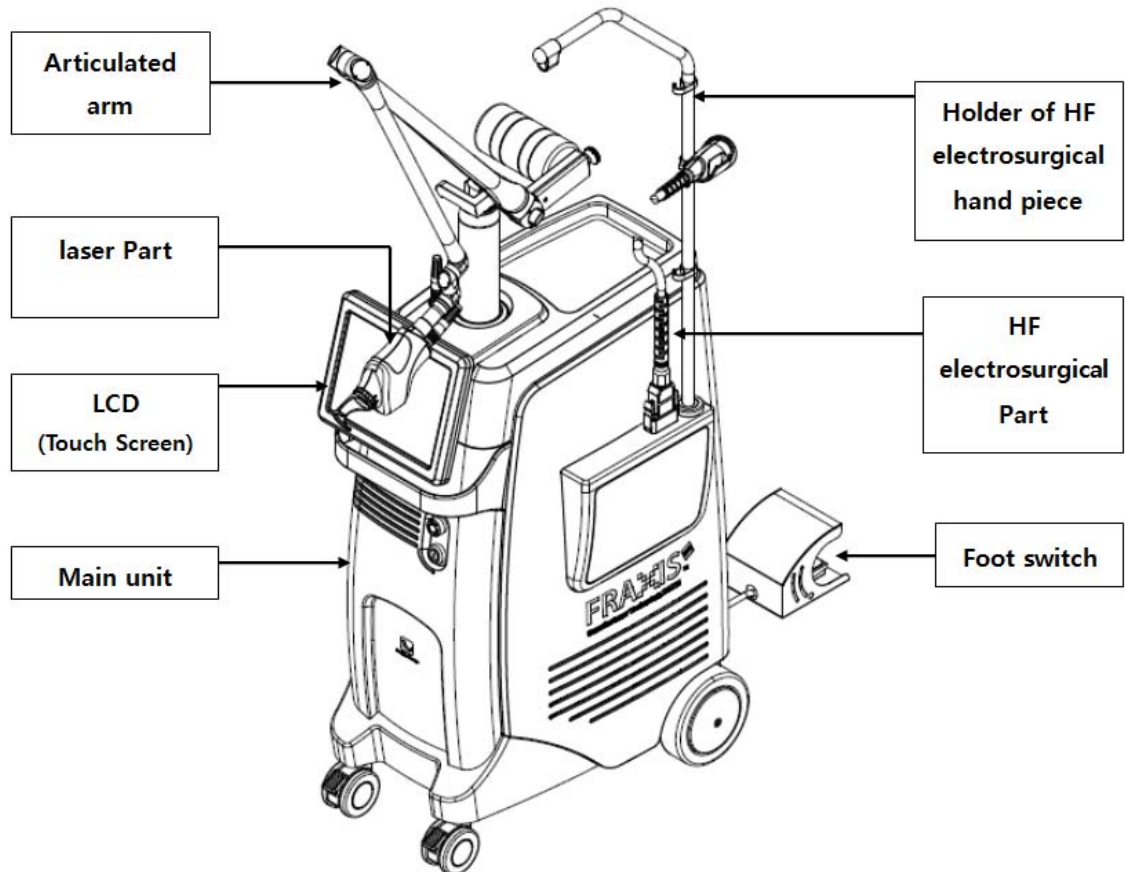

2. Description of Equipment

2.1 MAIN UNIT

1) Top

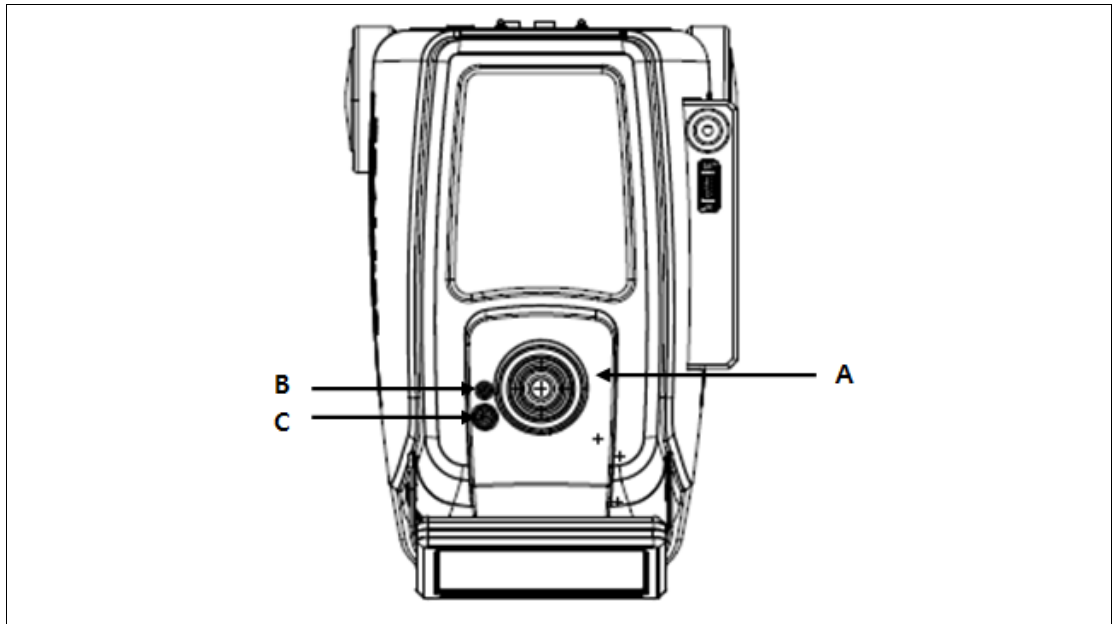

No	Name	Functions
A	Articulated arm terminal	Terminal that connects the main unit and laser hand piece articulated arm
B	Air joint connector	Terminal that passes compress air
C	Scanner cable connector	Terminal that connects scanner

2) Front

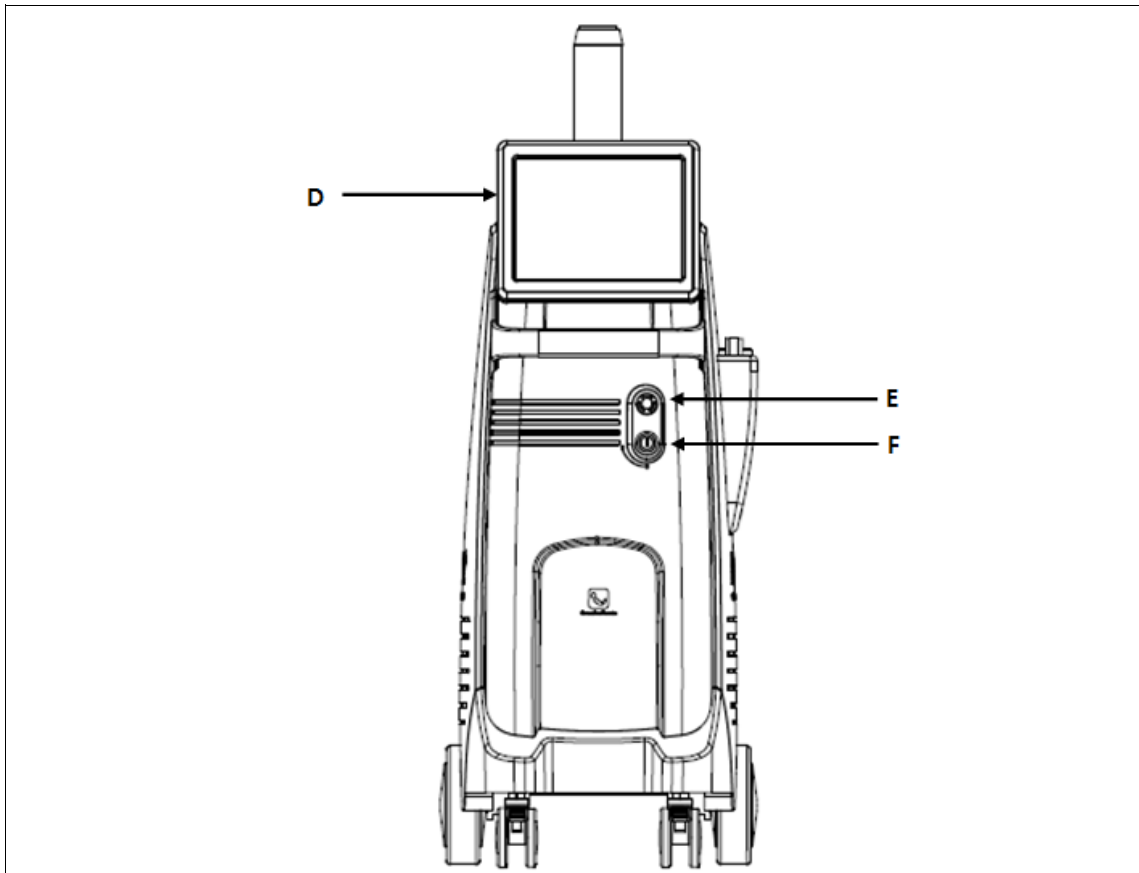

No	Name	Function
D	LCD monitor (touch)	Touch screen to set and display various functions (refer to "2.2 of Chapter 3" for description of display)
E	Emergency stop switch	Emergency stop switch to stop the device during emergency
F	Key switch	Key switch to turn the device power ON or OFF



Pressing the Emergency Laser emission stop switch causes immediate deactivation of the laser emission.

* If the emergency laser emission stop switch was pressed, the emergency laser emission stop switch turning the red button clockwise before restarting the system.

3) Rear

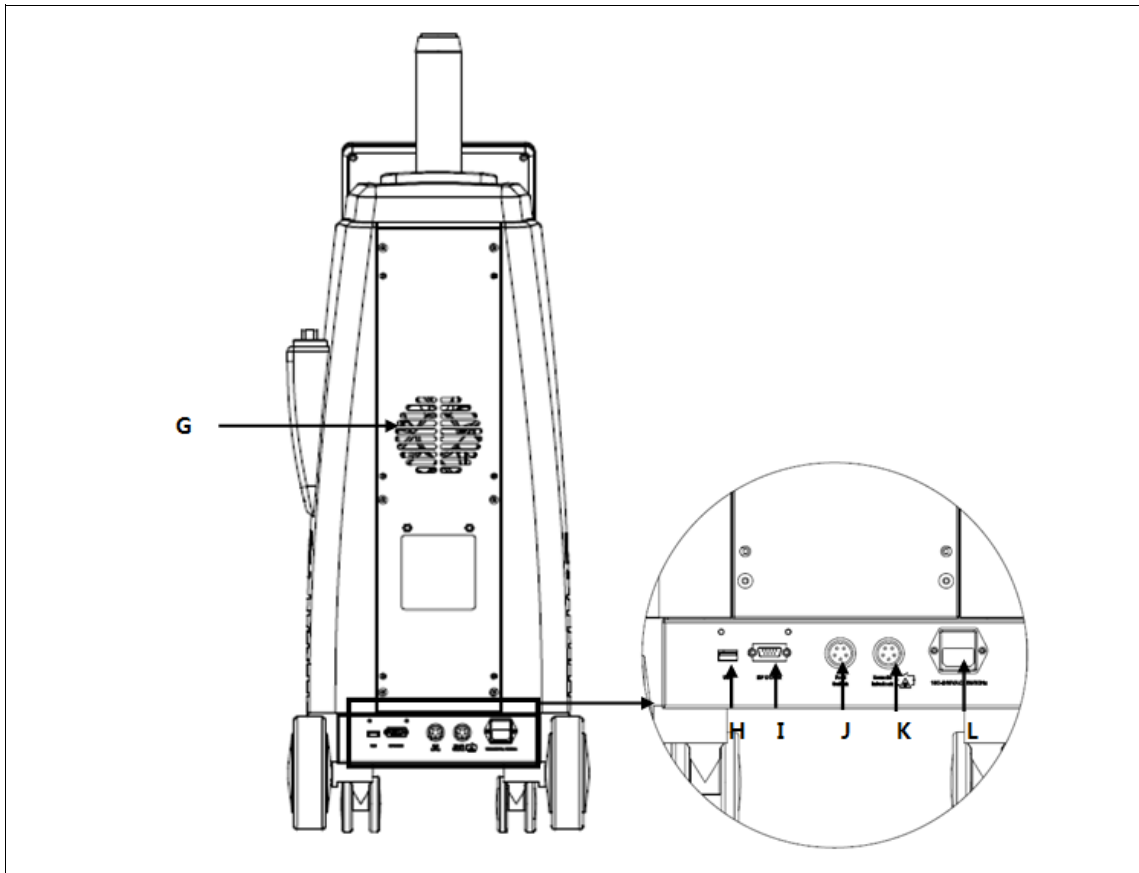

No	Name	Function
G	Vent	Part that draws internal heat out
H	USB terminal	USB connection for maintenance
I	ISP down terminal	ISP down cable connection for maintenance
J	Foot switch terminal	Foot switch connection
K	Remote interlock terminal	Remote interlock connection
L	Power cable terminal	Power cable connection

4) Side

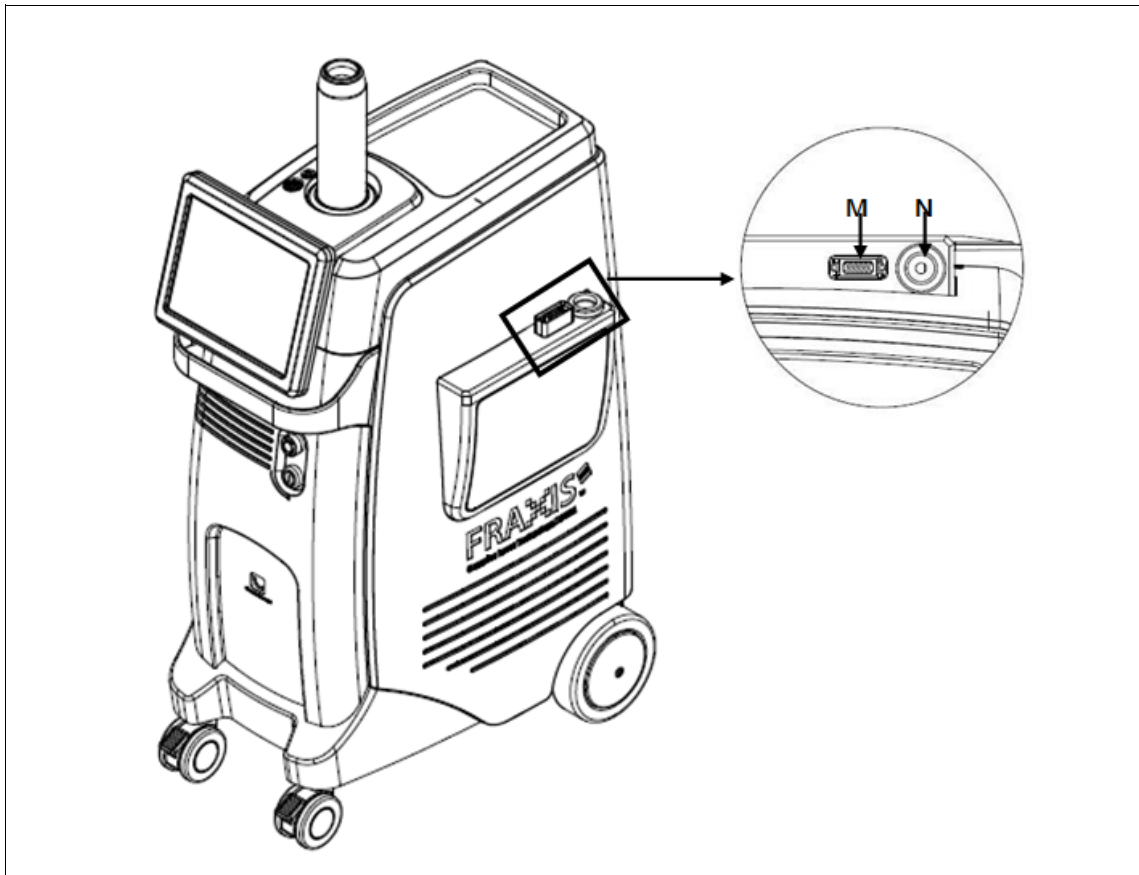

No	Name	Function
M	High frequency hand piece terminal	High frequency hand piece connection
N	High frequency hand piece holder	High frequency hand piece holder connection

2.2 Description of DISPLAY





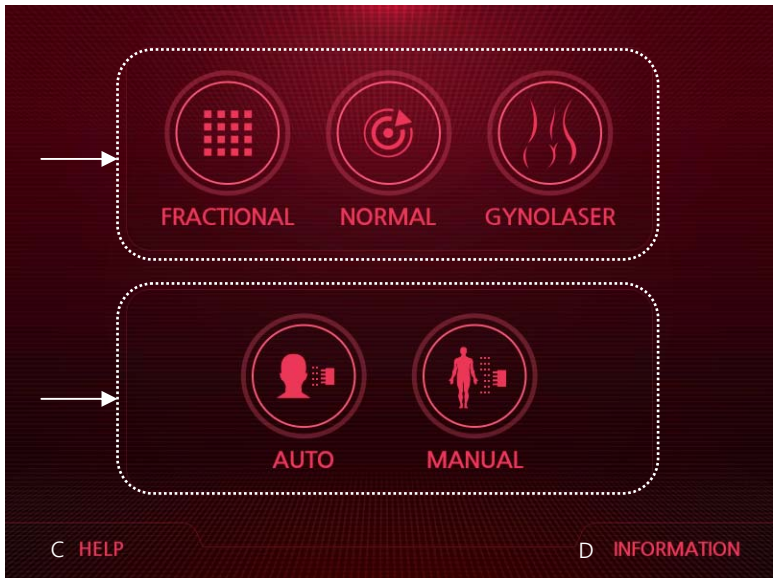

: Refer to "Chapter 4. Use of Equipment"

1) MAIN Screen

<p>A. Laser Operation mode</p> <p>B. High frequency Operation mode</p>		
No	Name	Function
A	Laser operation mode	Laser operation mode is composed of "FRACTIONAL" and "NORMAL"
B	High frequency operation mode	High frequency operation mode is composed of "AUTO" and "MANUAL"
C	Help	Help on menu
D	Information	Provides information about menu

2) FRACTIONAL Menu



No	Name	Function
A	Main menu	Icon to return to main menu
B	Volume control	Volume control icon
C	Standby / ready	Laser standby / ready selection icon
D	Laser output setting	Laser output setting icon <ul style="list-style-type: none"> - Energy: output energy setting - Repeat: output repetition time setting - Overlap: output repetition setting - Distance: dot distance setting - Scan pattern: irradiation pattern setting - Shape: irradiation shape setting
E	Up and down setting	Icons to adjust up  and down  in "D. Laser output setting"
F	Irradiation area setting	Laser irradiation area setting icons  : size control for each direction,  : overall size control   : size control
G	Preset	Icon to save frequently used values and current output setting. It can store up to 5 setting values.  icon is used)
H	Storage	Icon to save set value of the patient.
I	"CO2 NORMAL " change	"CO2 NORMAL " selection icon
J	AIMING	Aiming brightness setting icon







3) NORMAL Menu



No	Name	Function
A	Main menu	Icon to return to main menu
B	Volume control	Volume control icon
C	Standby / ready	Icon for selection of laser standby / ready
D	Laser output setting	Laser output setting icon - Mode: output mode setting - Power: output intensity setting - On time: output time within a cycle - Off time: resting time within a cycle - Pulse Width: output intensity - Pulse Rate: number of outputs per second
E	Up and down setting	Icons to adjust up ▲ and down ▼ in "D. Laser output setting"
F	Preset	Icon to save frequently used values and current output setting. It can store up to 5 setting values. ( icon is used)
G	Storage	Icon to save set value of the patient.
H	"CO2 FRACTIONAL " change	"CO2 FRACTIONAL " selection icon
I	AIMING	Aiming brightness setting icon

4) GYNO Laser Menu



No	Name	Function
A	Main menu	Icon to return to main menu
B	Volume control	Volume control icon
C	Standby / ready	Laser standby / ready selection icon
D	Laser output setting	Laser output setting icon - Energy: output energy setting - Repeat: output repetition time setting - Overlap: output repetition setting - Distance: dot distance setting - Scan pattern: irradiation pattern setting - Shape: irradiation shape setting
E	Up and down setting	Icons to adjust up  and down  in "D. Laser output setting"
F	Irradiation area setting	Laser irradiation area setting icons  : size control for each direction,  : overall size control   : size control
G	Preset	Icon to save frequently used values and current output setting. It can store up to 5 setting values. ( icon is used)
H	Storage	Icon to save set value of the patient.
I	AIMING	Aiming brightness setting icon

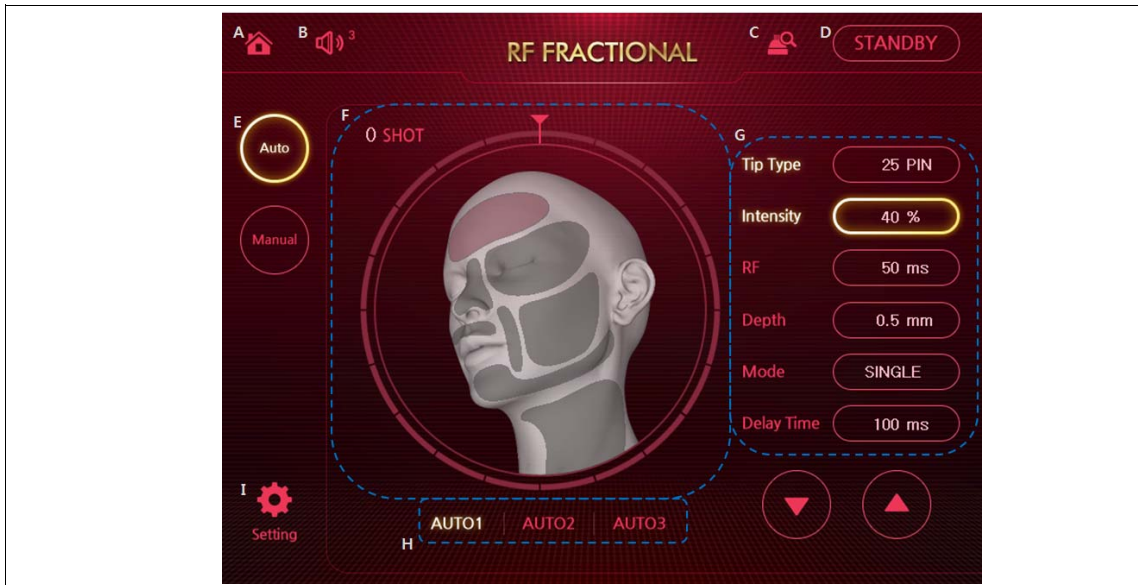

5) AUTO Menu



No	Name	Function
A	Main menu	Icon to return to main menu
B	Volume control	Volume control icon
C	Electrode status	Icon to check electrode status – to clean the electrode, click to show the following pop-up. 
D	Standby / ready	High frequency output standby / ready selection icon
E	Auto	Current mode is displayed (* click MANUAL icon below for movement)
F	Operation part setting	Operation part setting - Forehead - Eyes - Nose - Cheeks - Lips - Chin - Neck
G	Setting output display	High frequency output value is automatically configured upon selection of operation part
H	Auto mode	Composed of 3 types of auto
I	Configuration	Reconfigures automatic AUTO value

6) MANUAL Menu



No	Name	Function
A	Main menu	Icon to return to main menu
B	Volume control	Volume control icon
C	Electrode status	Icon to check electrode status – to clean the electrode, click to show the following pop-up. 
D	Standby / ready	High frequency output standby / ready selection icon
E	Manual	Current mode is displayed (* click auto icon above for auto movement)
F	Output setting display	High frequency output values displayed
G	High frequency output setting	High frequency output setting icon - Tip Type: needle electrode type setting - Intensity: high frequency output intensity - RF: high frequency output time - Depth: needle penetration depth - Mode: needle output time interval - Delay Time: needle output time
H	Preset	Icon to save frequently used values and current output setting. It can store up to 5 setting values. ( icon is used)
I	Storage	Icon to save set value of the patient.

7) Information Menu

: Provides information about menu and setting the parameters of use the device.

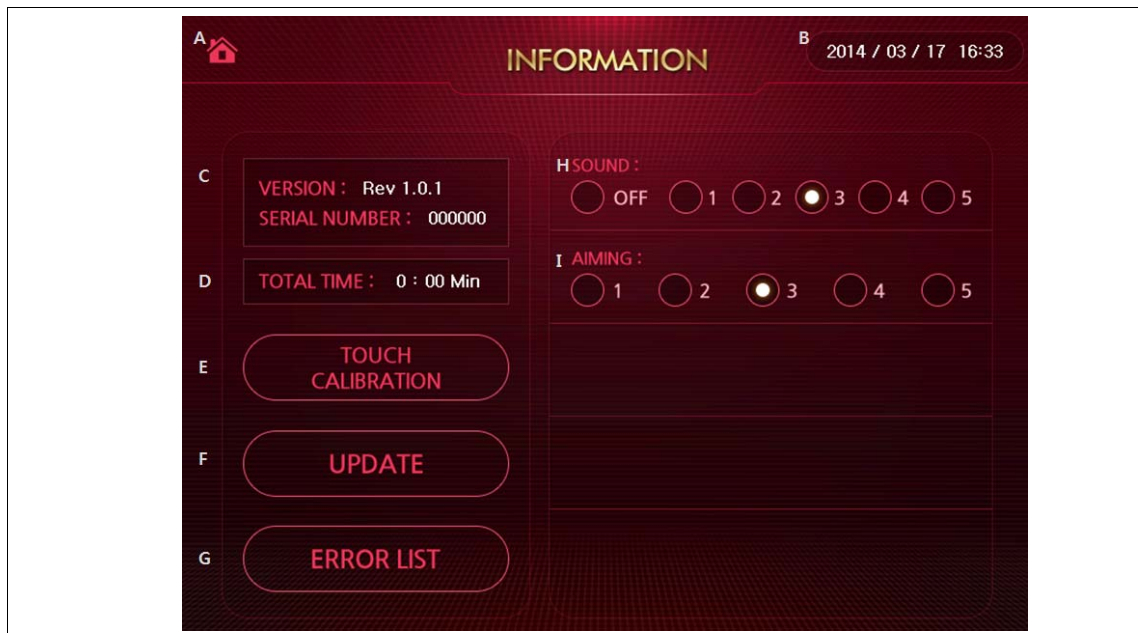

No	Name	Function
A	Main menu	Icon to return to main menu
B	Date	Display to Current date and time
C	VERSION & SERIAL NUMBER	Display to version and SN
D	TOTAL TIME	Display to Total shot time of laser
E	TOUCH CALIBRATION	Icon to calibration of laser
F	UPDATE	Icon to Update
G	ERROR LIST	Icon to error list
H	SOUND	Setting the operation sound
I	AIMING	Setting the brightness of the aiming beam

2.3 Description of Components

1) High Frequency hand piece (Bipolar Type)

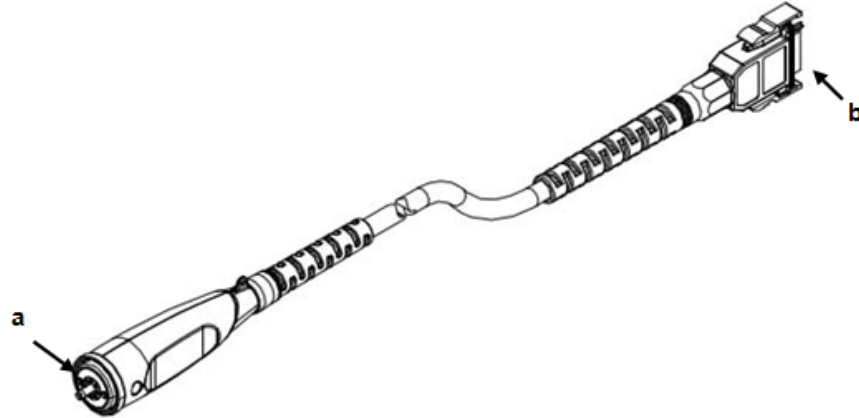

: As a high frequency output part, electrode for electric operator is connected.



No	Name	Function
a	Electrode connector	Part connected with electrode
b	Hand piece socket	Socket connected to main unit

2) Micro-needle type Electrode

: As an electrode used for high frequency operation, it is connected to high frequency hand piece. It is an optional component.

Image	Model Name	Function
	MTR-AC-25	No. of needles: 25ea Needle size: $\varnothing 0.25$ One time use
	MTR-AC-10	No. of needles: 10ea Needle size: $\varnothing 0.25$ One time use
	MTR-AC-C-10	No. of needles: 10ea Needle size: $\varnothing 0.25$ Insulation tip One time use

3) Scanner hand piece of LASER

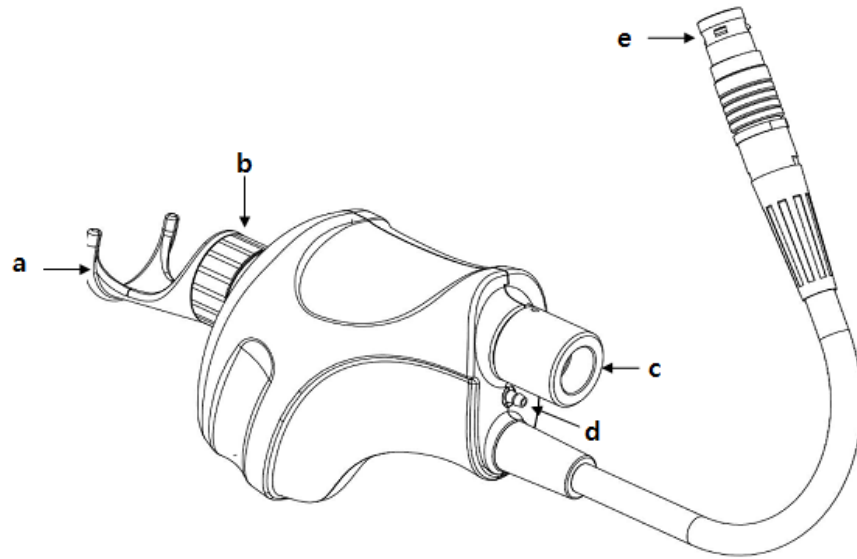

No	Name	Function
a	Beam guide (Separable)	Bar that adjusts laser focus to prevent shaking
b	Laser output	Laser output
c	Articulated arm connector	Articulated arm of Laser connector
d	Air joint connection terminal	Air joint connection
e	Hand piece cable connection terminal	Cable connection terminal connected to main unit (scanner part)

4) Gyno Laser hand piece

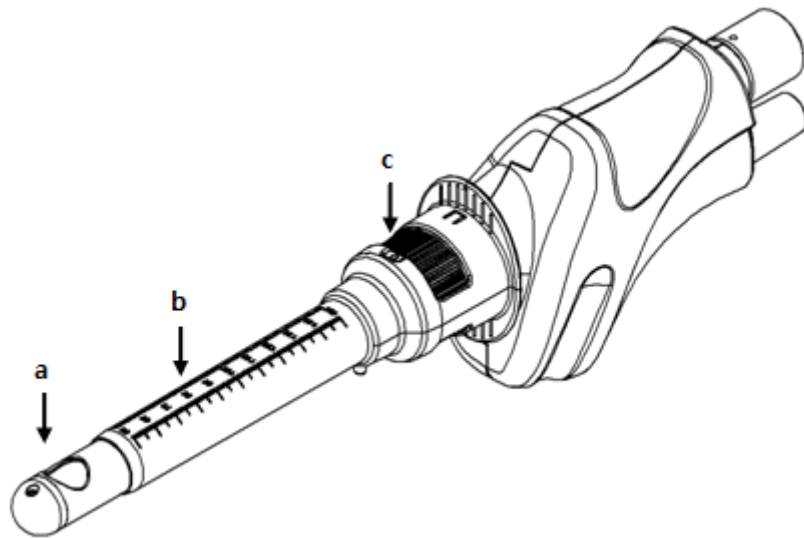

No	Name	Function
a	90 angle probe	Bar that adjusts laser focus to prevent shaking
b	i-slide	A guide that shows the depth of insertion in the human body, disposable.
c	Rotor	During the treatment procedure, the rotation number can be checked

5) Normal hand piece of LASER

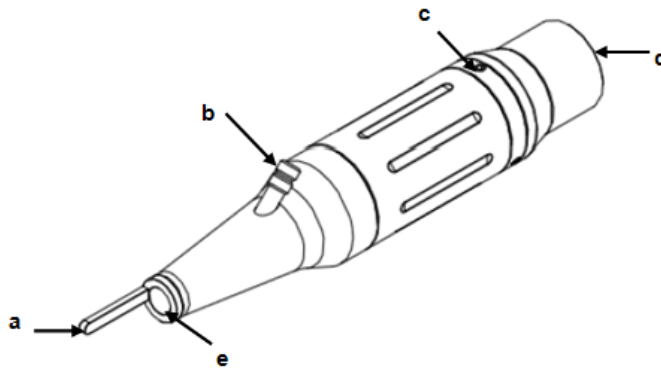

No	Name	Function
a	Aim bar	Bar that adjusts laser focus to prevent shaking
b	Air joint connector	Part connected to air joint
c	Laser size control knob	Part that controls laser size
d	Articulated arm connector	Articulated arm of Laser connector
e	Laser output	Laser output part

6) Articulated Arm of LASER hand piece

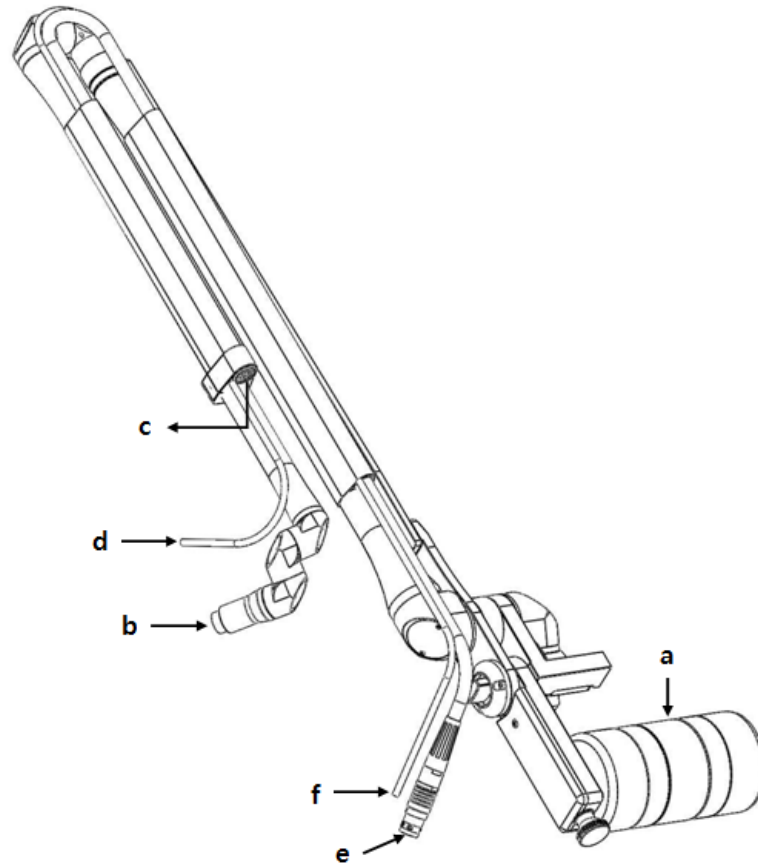

No	Name	Function
a	Main unit connector	Connector that connects main unit and articulated arm
b	Hand piece connector	Connector that connects hand piece and articulated arm
c	Scanner hand piece connector	When using the scanner hand-piece, connector that connects hand-piece and Main unit. (Connection part of Scanner hand-piece)
d	Air joint cable	When using the scanner hand-piece, Cable that allows compressed air to pass through (Connection part of Scanner hand-piece)
e	Scanner handpiece connector	When using the scanner hand-piece, connector that connects Hand-piece and Main unit. (Connection part of Main unit)
f	Air joint cable	When using the scanner hand-piece, Cable that allows compressed air to pass through (Connection part of Main unit)

7) Footswitch

: When manipulated by the operator, enables output(HF energy or Laser energy) to be produced and, when released disables output.

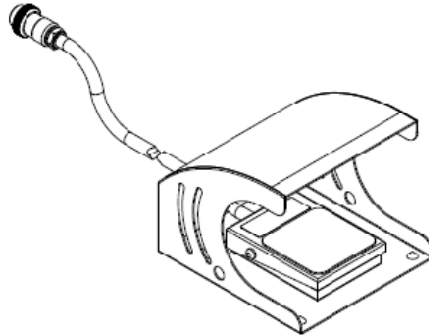



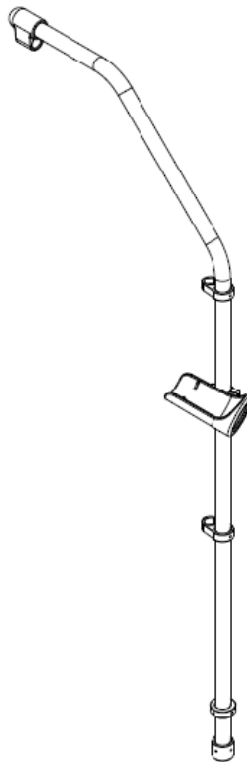

8) HF hand piece Holder



2.4 Description of Accessories

Below are items (accessories) that constitute this product.

Power cable	Power key
	
User goggle (for doctor)	Eye guard for patient
	
Remote interlock	
	

3. Installation of Equipment



- This product must be installed and used in a safety operation room within the hospital.
- The product must be transported and installed with its power turned off and on a safe and flat surface.
- During product installation, check power and system specifications.

3.1 Installation of Product

3.1.1 Connecting basic components

- 1) Connect the power cable to the power cord terminal on the back of the main unit.
- 2) Connect remote interlock.
- 3) Connect the foot switch to the foot switch terminal on the back of the main unit.

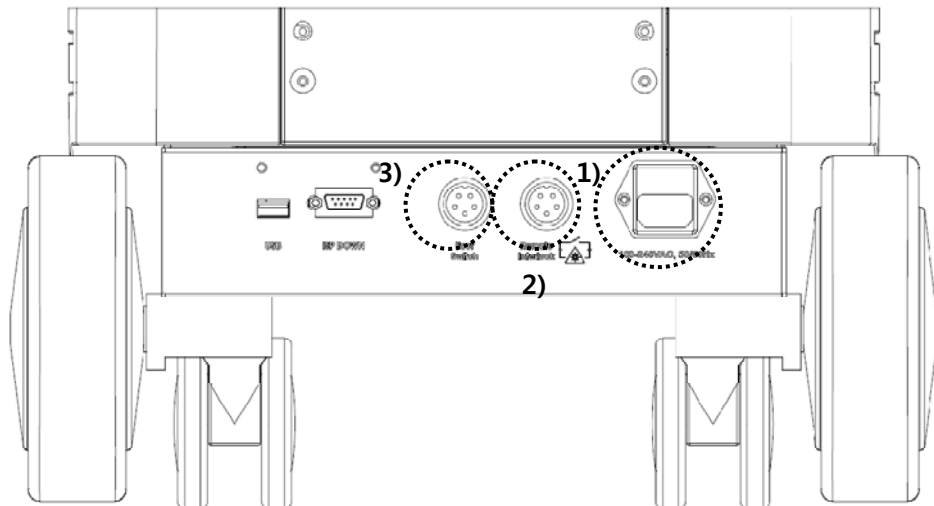

- When connecting the foot switch, set the foot switch in the direction of arrow on the main unit.
- An error message can appear and product may not function if connection is not properly done.
- The foot switch terminal and remote interlock are indicated on the connection terminal to prevent confusion.



- Be careful when articulated arm is moved or installed. The following situation might cause damage on the articulated arm.

1) In case operators hold two PIPEs of the articulated arm at the same time.

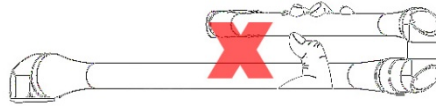

2) If users hold one side of the pipe in their hands and the weight of the entire articulated arm is supported by one side

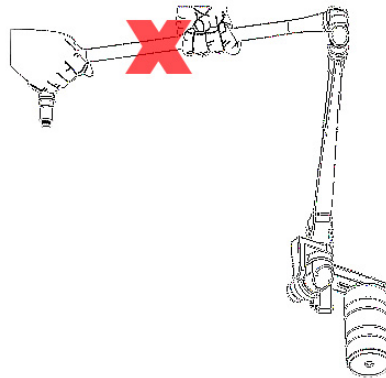

3.1.2 Installation of laser hand piece articulated arm

- 1) Open the red protection cap of the main unit articulated arm.
- 2) After vertically inserting the main unit connector of articulated arm into the main unit articulated arm, turn clockwise for firm connection.

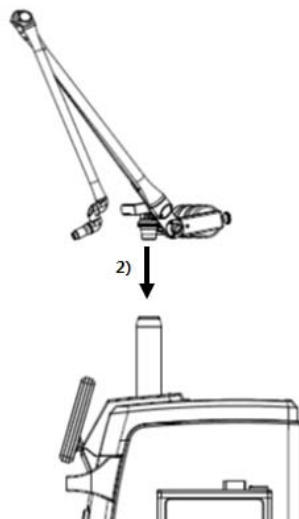

- 3) Vertically connect the articulated arm scanner cable to the scanner cable connector on the main unit in the direction of arrow.

- 4) Connect the air articulated cable of articulated arm to the air joint connector of the main unit.

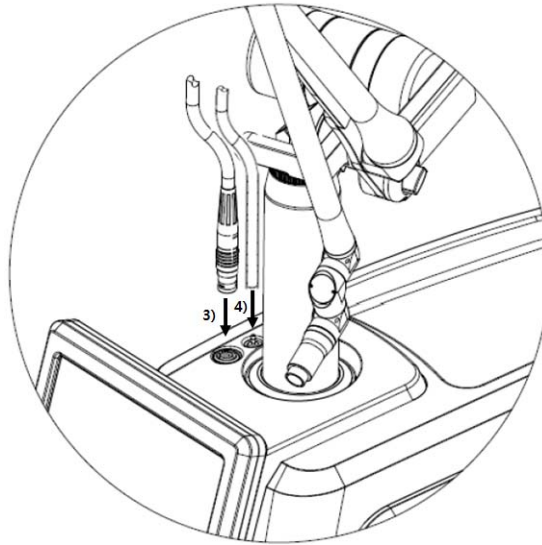

- When connecting the articulated arm, insert vertically and strongly turn clockwise. Movement of the articulated arm can become unstable during operation if not connected firmly.
- Connect the scanner cable in the direction of arrow until it makes a 'clicking' sound. Loose connection with the main unit can cause failure.
- The air joint cable is made of rubber hose with good elasticity. Fully insert so that it is not detached from the air joint connector on the main unit.



For user's convenient, you can adjust the weight of articulated arm, weight and position.

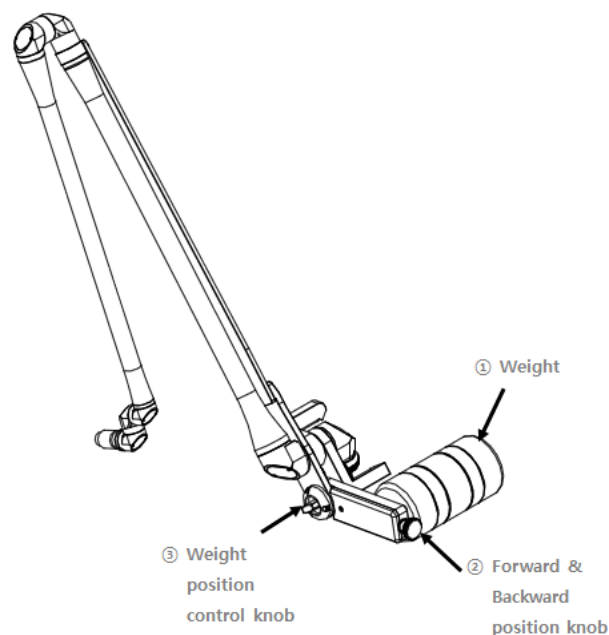

- The user feels different weight depending on the weight(①) position.
- To move the weight forward and backward, rotate Forward & Backward position knob(②).
- Weight position control knob(③) is for setting the weight position and set the articulated arm liner or L position.

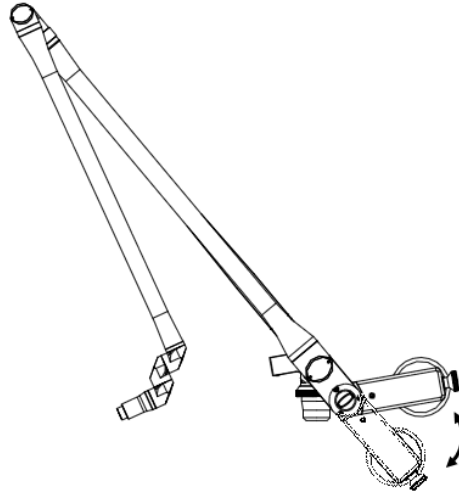

- Rotate the weight position control knob(③) counter clockwise, press the knob strongly, place the weight liner or L position.
For this setting, place the head of articulated arm on the shoulder or recommend to cooperate with other person for this setting.
- Set the weight the position where you want, Rotate the weight position control knob(③) clockwise for closing.

3.1.3 Connecting to scanner hand piece and beam guide

Inserting the beam guide into the scanner hand piece , turn clockwise for firm connection.

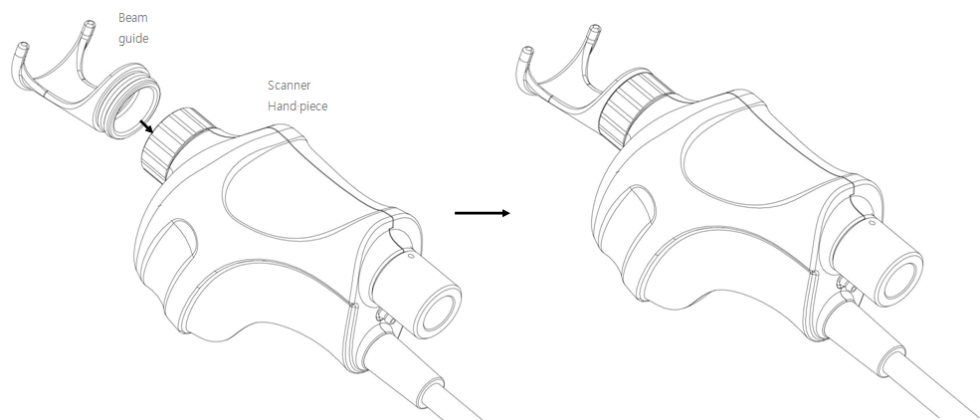

NOTE

First, the beam guide is provided in a state of being connected to the hand piece.

Beam guide is interchangeable.

Please follow the "3.1.3" when replacing the beam guide.

3.1.4 Connecting laser scanner hand piece

- 1) Horizontally insert the hand piece connector of articulated arm to the hand piece articulated arm and turn clockwise for firm connection.
- 2) Connect the scanner cable of articulated arm to the hand piece scanner connector for horizontal connection in the direction of arrow.
- 3) Connect the air joint cable of articulated arm to the hand piece air joint connector.

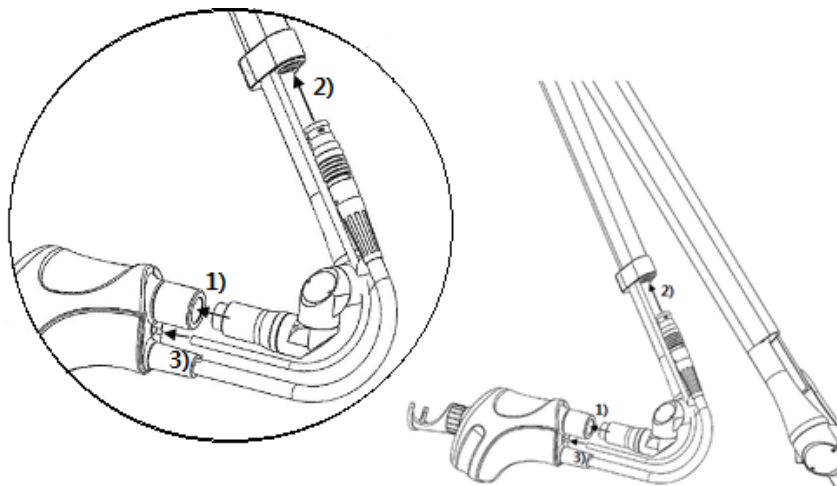

- When connecting the articulated arm, vertically insert and strongly turn clockwise. Movement of the articulated arm can become unstable during operation if not connected firmly.



- Connect the scanner cable in the direction of arrow until it makes a 'clicking' sound. Loose connection with the hand piece can cause failure.
- The air joint cable is made of rubber hose with good elasticity. Fully insert so that it is not detached from the hand piece air joint connector.

3.1.5 Connecting to Normal hand piece

- 1) Remove by turning it counter-clockwise protective cover.

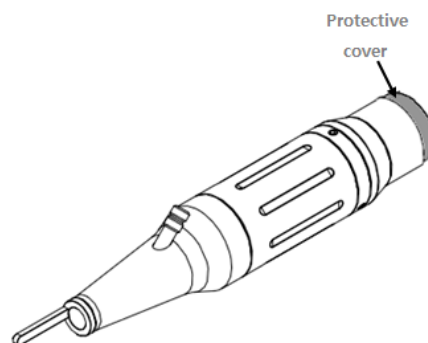

- 2) Horizontally insert the hand piece connector of articulated arm to the Normal hand piece and turn clockwise for connection.

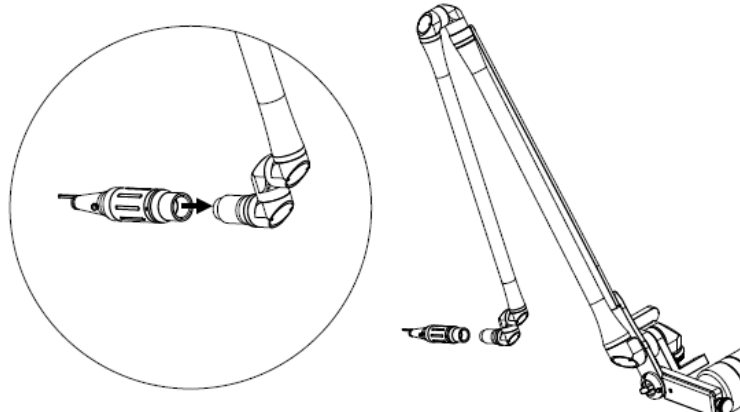

3.1.6 Connecting to GYNO laser hand piece and beam guide

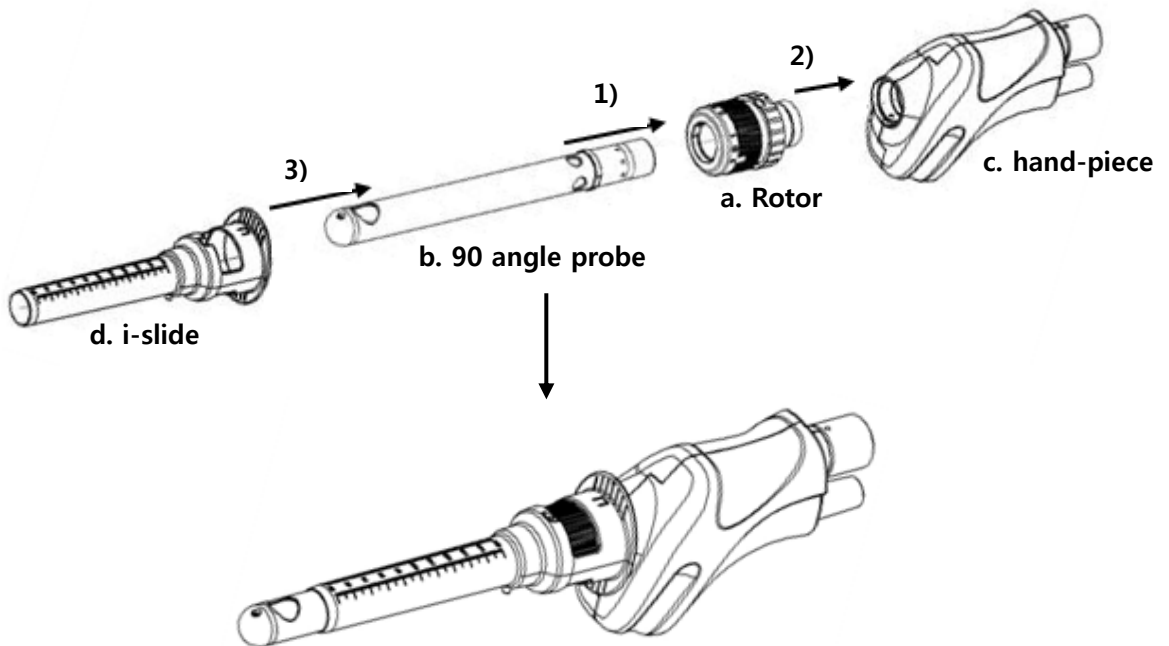

- 1) Insert the connector of 90 angle probe (b) into the Rotor's hole (a), so the rotation number can be checked by pulling the knob (marked as yellow) in the arrow direction.

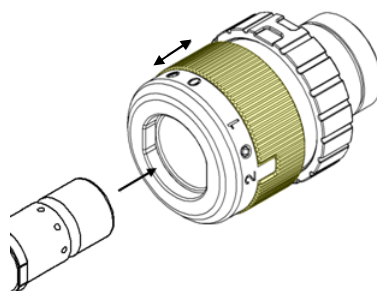

- 2) Insert "a"+"b" into the scanner hand piece in the arrow direction and then fix it by turning it clockwise.
- 3) Insert "d. i-slide" into the assembled "b. 90 angle probe" in the arrow direction and then fix it by turning it clockwise.



- Please insert the probe into rotors properly in order not to disconnect the probe from the Rotor during the treatment.
- Please make sure that operator uses Gynolaser by turning it in clockwise direction during the treatment

3.1.7 Connecting laser scanner hand piece

It is the same as in Clause 3.1.5.

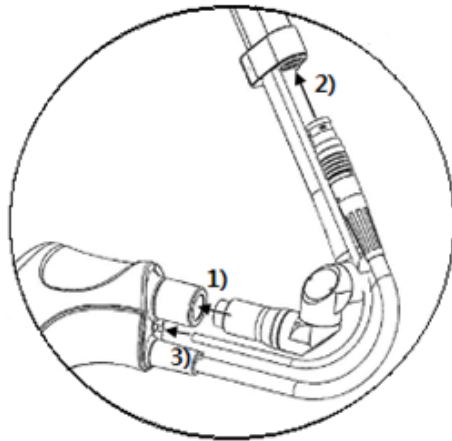

3.1.7 Installation of high frequency hand piece holder

- 1) Vertically insert the cable holder into the cable holder connector on top of the main unit and turn clockwise for firm connection.

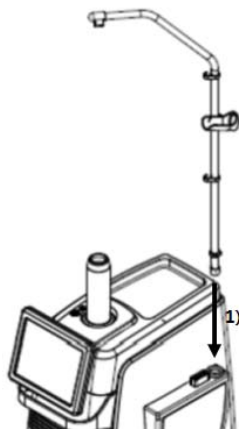



- Firmly connect the cable holder with the cable holder connector on the main unit.
- Operation can be disturbed by improper connection.

3.1.8 Connecting high frequency hand piece

- 1) Vertically connect the bipolar socket to the bipolar connector key hole on the main unit. When detaching the hand piece, vertically pull out by pressing the fixing holders on both sides of bipolar socket.

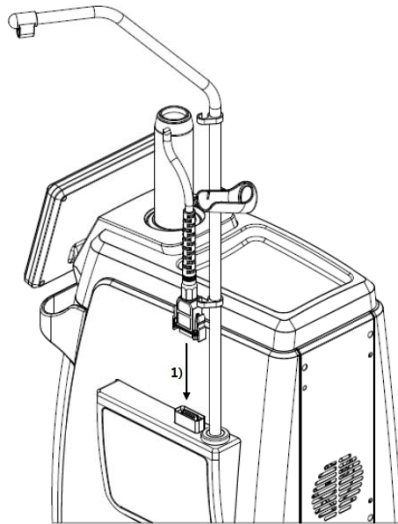

- 2) Attach the hand piece connector to the fixing hole of hand piece electrode connector and turn clockwise for connection.

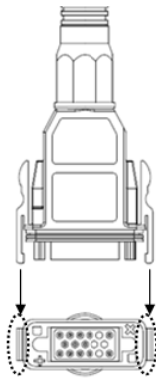

- When connecting bipolar hand piece, attach to the key hole between bipolar connector and bipolar socket.
- Vertically insert until clicking sound is created by the fixing holders on both sides of bipolar socket.
- An error message appears and the product does not function when connection is not done firmly.

3.1.9 Connecting Micro-needle type electrode

During connection of the Micro-needle type electrode, attach to the fixing hole between needle electrode and hand piece connector and turn clockwise for connection.

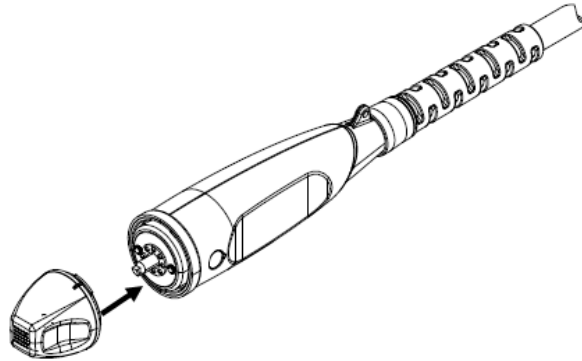

Not connected/bad



Normal connection

- Needle electrode connection status is displayed as below.
 - * Not connected or bad connection: red lamp turned on
 - * Normal connection: blue lamp on
- An error message appears and the product does not function when connection is not done firmly.

Chapter 4. Use of Equipment

Refer to "Chapter 3 Installation of equipment" for installation of this product.

All control modules and display screens appear on the front LCD monitor of the main unit. Since it is a touch screen, the screen is touched for control.



- Refer to " 2.2 of Chapter 3. Installation of Equipment " for detailed explanation on display

Insert the power key and turn the key switch to turn the power on. The following main screen will appear. Select each menu to move to the corresponding mode screen.

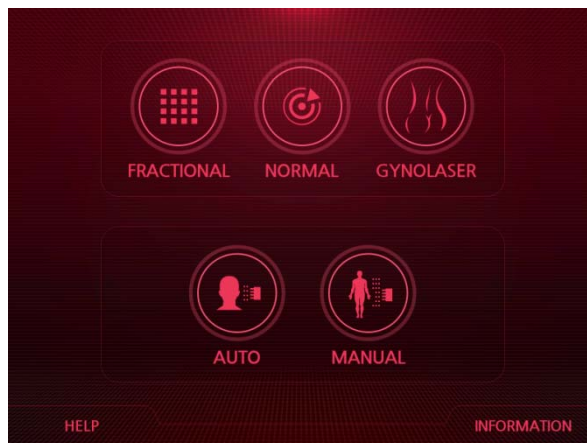

- **FRACTIONAL:** laser operation mode selected to use Scanner hand piece
- **NORMAL:** laser operation mode selected to use Smart Surgi hand piece
- **GYNOLASER:** laser operation mode selected to use Gyno hand piece
- **AUTO:** high frequency operation mode that automatically provides parameters for each operation part (using bipolar hand piece)
- **MANUAL:** high frequency operation mode controlled by the user
- **HELP:** help on control menu
- **INFORMATION:** information menu



- Turn the power on after completing installation. If the power is turned on or each mode is entered without completing installation, an error message appears and the product does not function properly.
- You cannot enter two modes at the same time, Finish a mode before entering another mode.



1. FRACTIONAL Mode

Select Fractional icon on the standby screen to show CO2 fractional screen.

Configuration screen	
Method of use	
<p>1) Use icons on the left side to set laser output values.</p> <p>Select the icon to set among icons on the left. ▲ ▼ icons appear at the center of the screen. Use (up) and (down) to set output values.</p> <ul style="list-style-type: none"> - Energy: output energy setting - Repeat: output repetition time setting - Overlap: output repetition setting - Distance: dot distance setting - Scan pattern: irradiation pattern setting - Shape: irradiation shape setting <p>2) Use icons on the right side of the screen to set irradiation area.</p> <p>3) Use storage to save current output value.</p> <p>Press number button on storage and press SAVE to save the current value in the designated number.</p> <p>ex) Select 1 on storage and press SAVE to save the current value in 1.</p> <p>When 1 is pressed later on, the saved value is automatically entered.</p> <p>4) When setting is done, press STANDBY to change to READY state.</p> <p>Laser is irradiated by pressing the foot switch in READY state.</p> <p>5) After irradiation, press 🏠 (Home) at the top to return to the standby screen.</p> <p>6) Use icons to set(change) operation sound volume. (Set value : off~5 steps)</p> <p>7) Change to "CO2 NORMAL" menu.</p> <p>8) Use icons to set Aiming brightness. (Set value : 1~5 steps)</p> <p>9) Use icons to save set value of the patient – Attach a separate description 'Methods to Use the Storage'</p>	

2. NORMAL Mode

CO2 Normal screen appears by selecting Normal on the standby screen.

Configuration screen

Method of use
<p>1) Use icons on the left side to set laser output values.</p> <p>Select the icon to set among icons on the left. ▲ ▼ icons appear at the center of the screen. Use (up) and (down) to set output values.</p> <ul style="list-style-type: none"> - Mode: output mode setting - Power: output intensity setting - On time: output time within a cycle - Off time: resting time within a cycle - Pulse Width: output intensity - Pulse Rate: number of outputs per second <p>Configuration values are enabled or disabled depending on the output mode.</p> <ul style="list-style-type: none"> - CW: Power setting - Pulse: Power, On time, Off time settings - Pulse Single: Power, On time settings - Ultra: Pulse Width, Pulse Rate settings <p>2) Use storage to save current output value.</p> <p>Press number button on storage and press SAVE to save the current value in the designated number.</p> <p>ex) Select 1 on storage and press SAVE to save the current value in 1.</p> <p>When 1 is pressed later on, the saved value is automatically entered.</p> <p>3) When setting is done, press STANDBY to change to READY state.</p> <p>Laser is irradiated by pressing the foot switch in READY state.</p> <p>4) After irradiation, press  (Home) at the top to return to the standby screen.</p> <p>5) Use icons to set(change) operation sound volume. (Set value : off~5 steps)</p> <p>6) Change to "CO2 FRACTIONAL" menu.</p> <p>7) Use icons to set Aiming brightness. (Set value : 1~5 steps)</p> <p>8) Use icons to save set value of the patient – Attach a separate description 'Methods to Use the Storage'</p>

3. GYNO Mode

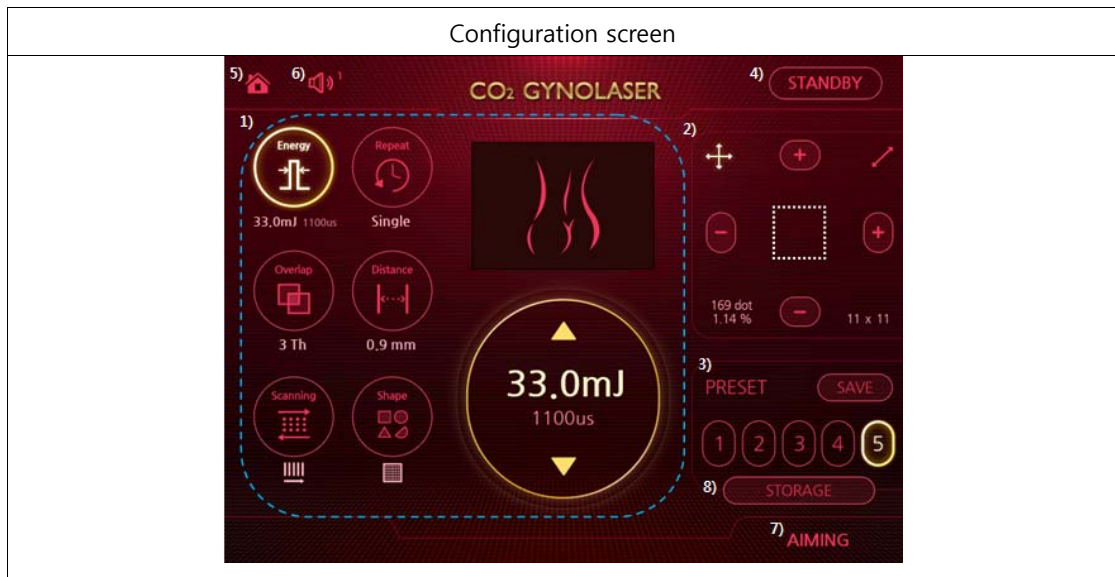
GYNO Laser screen appears by selecting Normal on the standby screen.



Method of use

1) Use icons on the left side to set laser output values.

Select the icon to set among icons on the left. ▲ ▼ icons appear at the center of the screen. Use (up) and (down) to set output values.

- Energy: output energy setting
- Repeat: output repetition time setting
- Overlap: output repetition setting
- Distance: dot distance setting
- Scan pattern: irradiation pattern setting
- Shape: irradiation shape setting

2) Use icons on the right side of the screen to set irradiation area.

3) Use storage to save current output value.

Press number button on storage and press SAVE to save the current value in the designated number.

ex) Select 1 on storage and press SAVE to save the current value in 1.

When 1 is pressed later on, the saved value is automatically entered.

4) When setting is done, press STANDBY to change to READY state.

Laser is irradiated by pressing the foot switch in READY state.

5) After irradiation, press  (Home) at the top to return to the standby screen.

6) Use icons to set(change) operation sound volume. (Set value : off~5 steps)

7) Use icons to set Aiming brightness. (Set value : 1~5 steps)

8) Use icons to save set value of the patient – Attach a separate description 'Methods to Use the Storage'



NOTE

The pop-up window as below appears as you touch 'AIMING' of 'other menu field

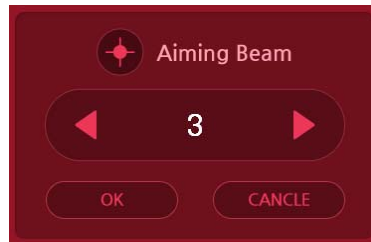

If you touch 'OK' after adjusting the brightness of aiming beam using the arrows in the pop-up window, the setting is completed and the screen is changed into the mode screen, and if you touch 'CANCEL', the setting is cancelled and the screen is changed into the mode screen.

4. AUTO Mode

RF Fractional(Auto) setting screen appears by selecting Auto on the standby screen.

Configuration screen	
Method of use	
<ol style="list-style-type: none"> 1) Select the operation part on the image at the screen center. Energy is automatically configured for each part. 2) Select AUTO1, AUTO2, AUTO3 at the bottom of the screen. Energy intensity is automatically configured and displayed on the right side for each step. 3) When setting is done, press STANDBY to change to READY state. High frequency is sent out through the needle electrode of high frequency hand piece by pressing the foot switch in READY state. 4) After irradiation, press  (Home) at the top to return to the standby screen. 	

* Configuration value for each AUTO Mode

Area parts	AUTO 1			AUTO 2			AUTO 3		
	Intensity	RF time	Depth	Intensity	RF time	Depth	Intensity	RF time	Depth
① Forehead	40~50	50~70	0.5~0.8	40~50	50~70	0.5~0.8	40~50	50~70	0.5~0.8
② Eyes	40~50	50~70	1.0~1.2	40~50	50~70	1.0~1.2	40~50	50~70	1.0~1.2
③ Cheeks	50~60	50~70	1.2~1.5	20~30	150~200	1.5~2.0	10~30	200~250	1.5~2.0
④ Wrinkles	50~60	50~70	1.5~2.0	20~30	150~200	1.5~2.5	10~30	200~250	1.5~2.5
⑤ Chin	40~50	50~70	1.2~1.5	20~30	150~200	1.2~1.5	10~30	150~200	1.2~1.5
⑥ Nose	50~60	50~70	1.2~1.5	20~30	150~200	1.2~1.5	10~30	150~200	1.2~1.5
⑦ Neck	40~60	50~70	1.5						

5. MANUAL Mode

RF Fractional (Manual) screen appears by selecting Auto on the standby screen.

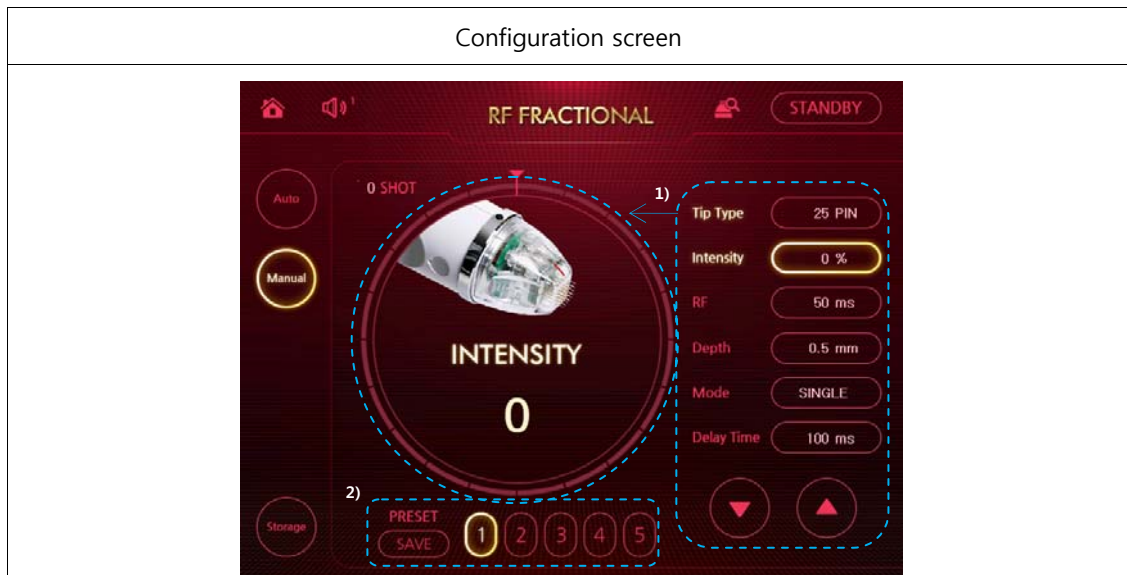

Method of use

1) Use icons on the right side of the screen to configure high frequency output values.



icons appear at the center of the screen by selecting icons on the left side.

Use (up) and (down) to configure output mode and value.

- Tip Type: needle electrode type setting
- Intensity: high frequency output intensity
- RF: high frequency output time
- Depth: needle penetration depth
- Mode: needle output time interval
- Delay Time: needle output time

2) Use storage to save current output value.

Press number button on storage and press SAVE to save the current value in the designated number.

ex) Select 1 on storage and press SAVE to save the current value in 1.

When 1 is pressed later on, the saved value is automatically entered.

3) When setting is done, press STANDBY to change to READY state.

Laser is irradiated by pressing the foot switch in READY state.

4) The following screen appears when the device is operated.



5) After irradiation, press  (Home) at the top to return to the standby screen.

** Common precautions for modes **



- Turn the power on after completing installation. When the power is turned on or each mode is attempted without completing installation, an error message appears and the product will not function properly.
- Configure output values in STANDBY state and convert to READY state when setting is done.
- Before operation, check the configured parameters and convert to READY state.
- Since energy is irradiated by pressing the foot switch (MTR) mode in READY state, aim the hand piece at the body part of the patient being treated. Convert to READY state and operate the foot switch or volume switch.



- Two hand pieces cannot be used at the same time. Finish a mode before entering another mode.
- Access of the foot switch and volume switch is prohibited to all individuals other than the authorized user (doctor).

Chapter 5. Technical Specification

Input power	100-240VAC, 50/60Hz, 650VA			
Operation Mode	Treatment for Laser	FRACTIONAL , NORMAL		
	Treatment for HF electrosurgical	AUTO, MANUAL		
Specification	Laser part	Laser type	CO2 LASER	
		Laser classification	Class 4(according to IEC60825-1;2007)	
		Output power	up to 30W (up to 150mJ at 5,000us)	
		Wavelength	TEM00(10.6um)	
		Pulse duration	20 - 5,000us	
		Repetition	0.2-2 sec/single	
		Overlap	1-10th	
		Distance	0.1-2.0mm	
		Treatment Area	1x1~20x20mm	
		Pixel Quantity	Up to 40,401	
		Pixel Size	- Scanner handpiece : ≥100 micron - Smart Surgi hand piece : 0.2, 0.3, 0.5, 0.7, 0.9, 1.1, 1.3mm	
		Cooling	Air Cooling	
		Optical Guide	Articulated Arm	
	HF electrosurgical Part	Max. Output power	Max. 25W(load 500ohm)	
		Intensity of output for mode	Refer to "Table 1."	
		RF frequency	2MHz ±10%	
		Intensity	0 ~ 100 LEVEL(2/5/10 STEP)	
		Repetition	0.2 / 0.5 / 1 / 2 sec / Single	
		Adjustable depth	0.5 ~ 3.5mm(0.1 step)	
		RF duration	50ms ~ 950 ms	
Size (Weight)	Main unit	410 × 601mm × 1071mm[W x D x H], 45kg		
	Articulated arm	1400mm(Height), 8kg		
	HF electrosurgical handpiece holder	900mm(Height), 1kg		

INTENSITY	10Ω		50Ω		100Ω		200Ω		500Ω		1000Ω	
	Vp-p	RMS	Vp-p	RMS	Vp-p	RMS	Vp-p	RMS	Vp-p	RMS	Vp-p	RMS
10	2.68	0.69	7.76	2.56	23.2	4.81	21.2	5.91	34.4	8.8	36.4	11.3
20	5.24	1.6	16.2	5.41	32.8	8.36	43.6	13.8	68.8	20.7	85.6	26.2
30	8.48	2.51	26.2	8.97	47.2	13.8	69.6	22.6	140	34.4	134	42.3
40	11.7	3.62	36.2	12.6	62.4	19.4	100	31.5	172	47.9	183	59.3
50	14.3	4.47	45.4	15.8	75.2	24	120	39.1	212	59.6	252	73.9
60	18.4	5.06	57.6	18.1	87.2	27.8	140	45.7	240	70.2	292	86.2
70	20.4	5.72	65.6	20.6	96.8	32.1	158	52.1	272	80	328	97.7
80	23.2	6.46	72	23.5	109	36.2	186	59.4	344	89.3	364	110
90	24.8	7.18	81.6	26.5	121	40.7	208	66.8	368	99.7	400	123
100	26.8	7.93	88.8	29.4	134	45.3	230	74.2	400	112	436	136

[Table 1. Intensity of output for mode]



Use of controls or adjustments or performance of procedures other than those specified herein may result in hazardous radiation exposure.

Chapter 6. Output power characteristics

Power readouts agree with actual power into rated load to within 20%, whichever is greater.

Intensity	Output Power	Output frequency	Vp-p max	Crest Factor
10	25W@500Ω	2MHz	550V	550V/188V = 2.92

1. Output power Graphs

- Output power versus power setting

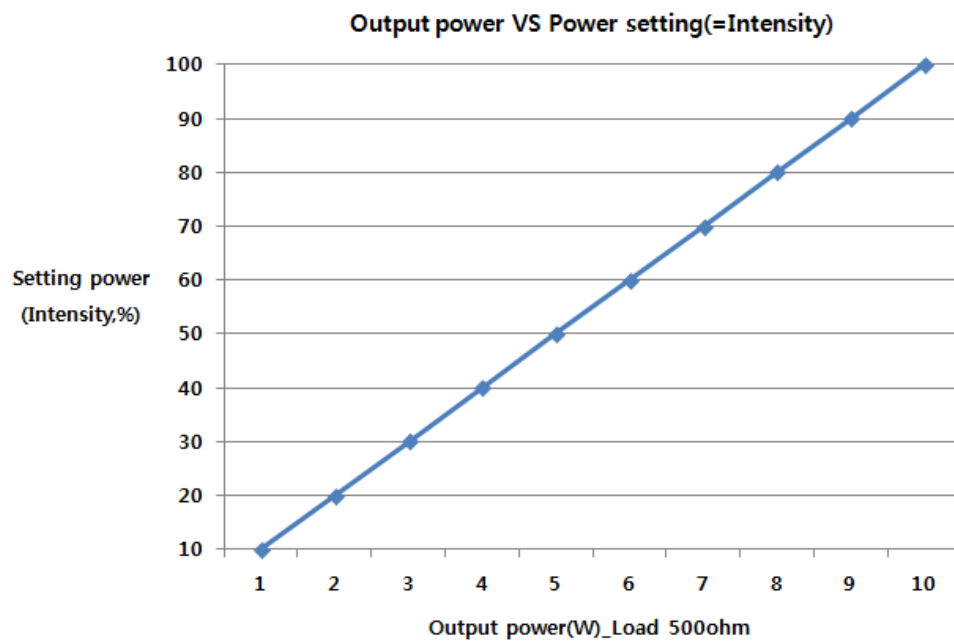

- Power setting versus voltage(Vp-p)

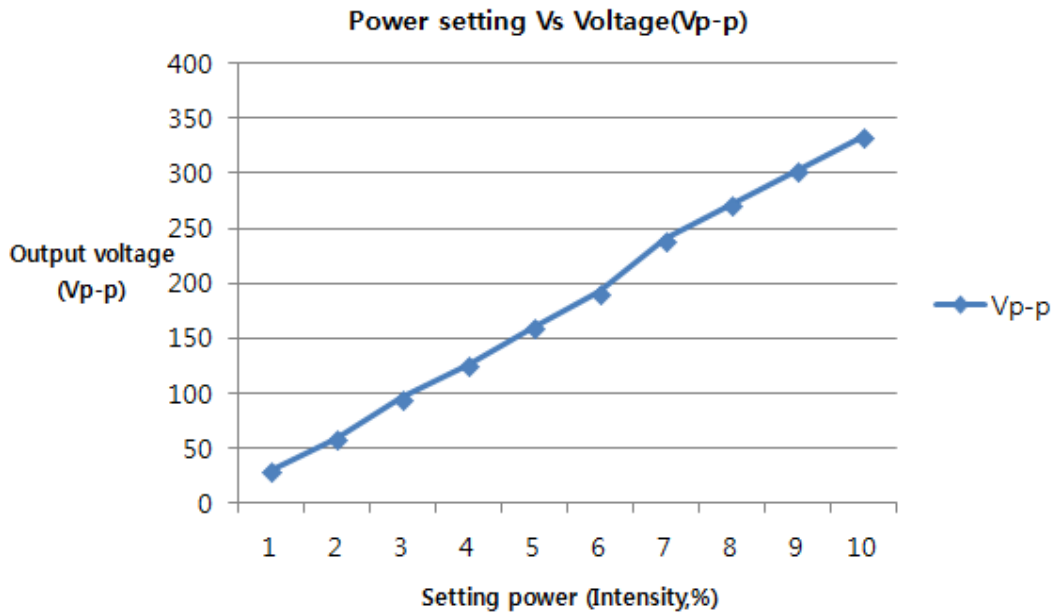

- Output power versus Load

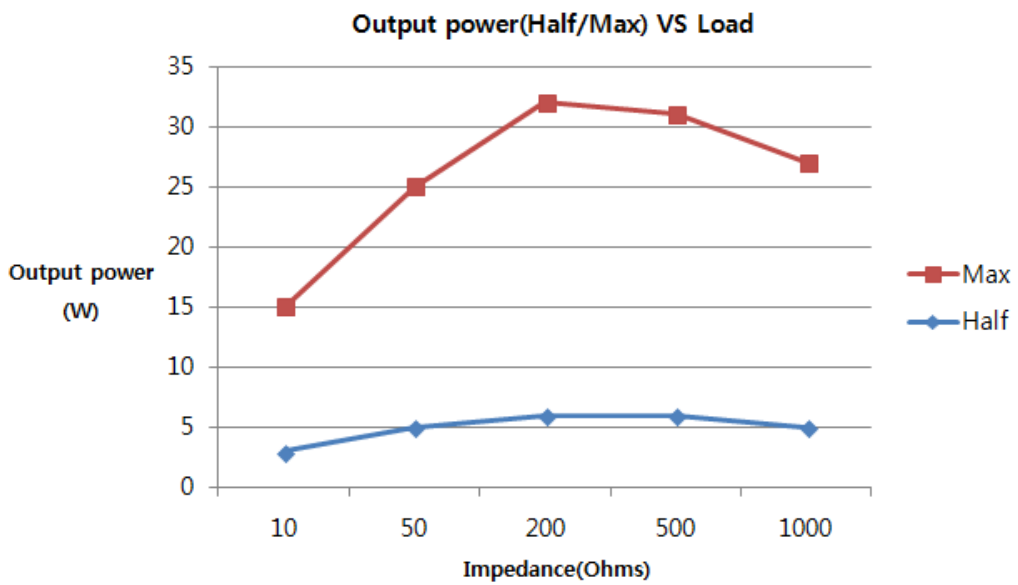



Chapter 7. Explanation on Pop-up Messages

The pop-up message is a warning or notifying pop-up message appearing during use or operation. If you encounter the following message, stop the treatment immediately, check the content of the message, and then readjust the equipment.

1. Warning Message

Screen indicating a warning message.

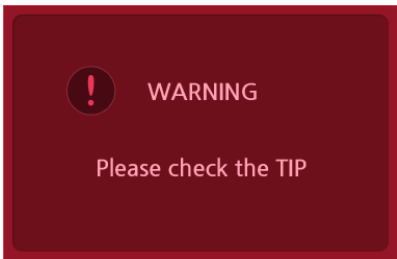
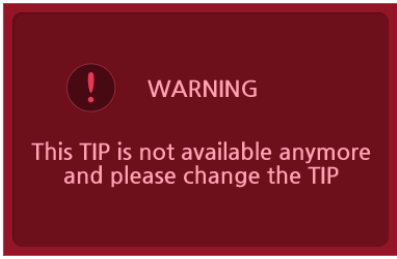
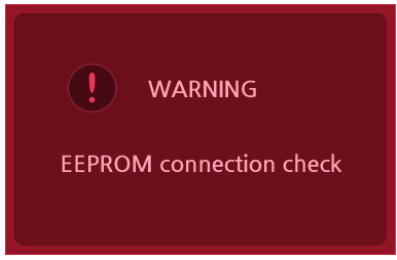
A warning message is pop-uped on the screen as follows;

Image	Content of Error	Solutions
	Checking Needle tip connection	When the needle tip is not connected or not connected properly, the warning sign comes. Check whether or not the needle tip is connected, and connect it again. Must connect the Needle tip to Hand piece completely.
	Over count of Needle Tip	TIP SHOT COUNT comes to MAXIMUM limited number. Please change the new needle tip.
	Checking Error for Shot storage system	In case of the problem with the storage of Needle shot counting. Please contact ILOODA Co., Ltd or agent.
	Over output warning	In case of increasing RF over 400, the warn comes. Check the patient and adjust the intensity.

2. Error Message

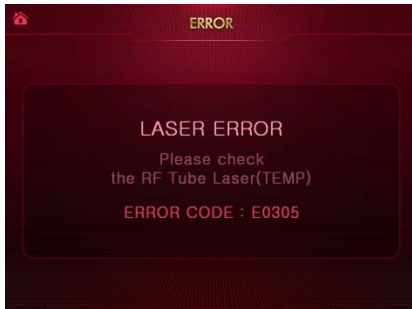

Screen of Error Message

The error message as the left side pops up and the message in the box varies with the content of the error.

Refer to the following table for the contents of the errors.

Name of Error	Content of Error	Solutions
FOOT SWITCH ERROR	FOOT SWITCH ERROR Please check the foot switch ERROR CODE : E0501	Error message appearing when the foot switch on the back side of the console is disconnected. Check whether or not the foot switch is connected, and connect it again.
INTERLOCK ERROR	INTERLOCK ERROR Please check the interlock ERROR CODE : E0401	Error message appearing when interlock of back side of main body is not connected. Check if it is connected or not, and if not, reconnect it.
SCANNER ERROR	SCANNER ERROR Please check the Scanner ERROR CODE : E1103	Error message appearing when scanner connector is not connected or is pulled out in fractional mode. Check if it is connected or not, and if not, reconnect it.
LASER ERROR	LASER ERROR Please check RF Tube Laser(TEMP) ERROR CODE : E0305	Error message appearing when the temperature of the RF Tube laser is raised 60°C or more. Please contact ILOODA Co., Ltd or authorized agent
LASER ERROR	LASER ERROR Please check the RF Tube Laser(Ready) ERROR CODE : E0303	Error message appearing when the RF Tube laser fails. Please contact ILOODA Co., Ltd or agent.
SERIAL ERROR	SERIAL STATUS ERROR Please check the Serial Status ERROR CODE : E1301	Error message appearing when the communication error between two MICOM. Please contact ILOODA Co., Ltd or agent.

3. Information Message

The screen of information message.

The message window pop-uped on the screen as follows;

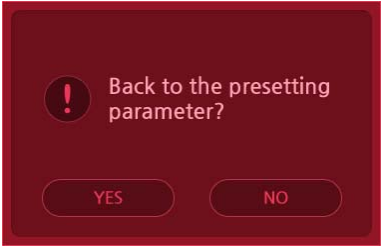
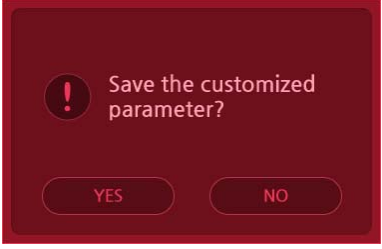
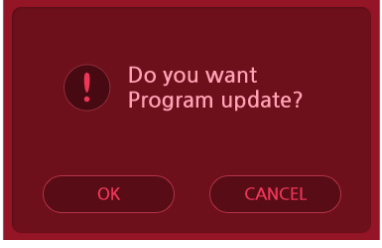
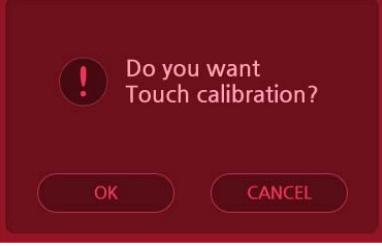
Message	SOLUTION
	<p>It happens when it is pressed BACK button for AUTO mode at the USER PREESET Mode.</p>
	<p>When delete the all USER PREESET parameter, this message comes</p>
	<p>When touch UPDATE button at the INFORMATIN mode, this message comes</p>
	<p>When touch Calibration button at the INFORMATIN mode, this message comes</p>

Appedix1. Label and Symbols



The position of the label can be changed arbitrarily manufacturer.

1.1 Label

1) Main Unit

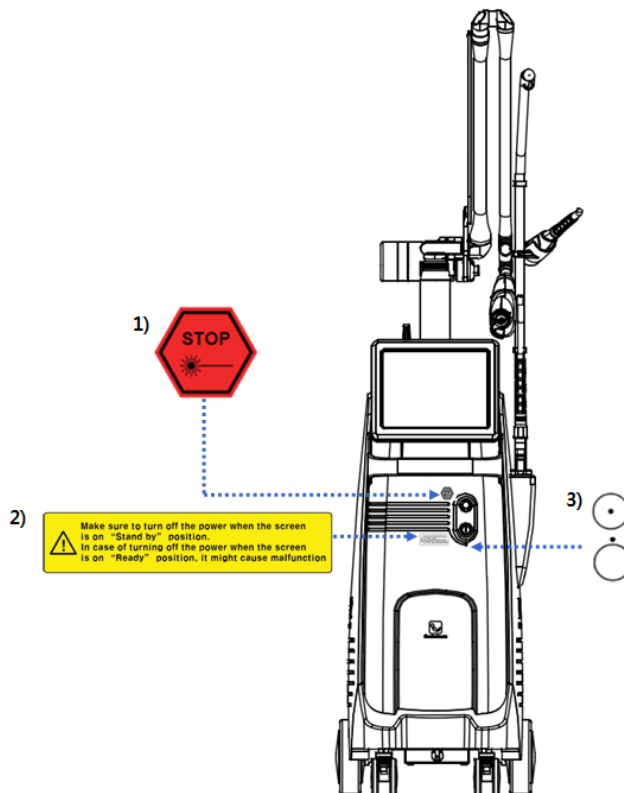

- FRONT





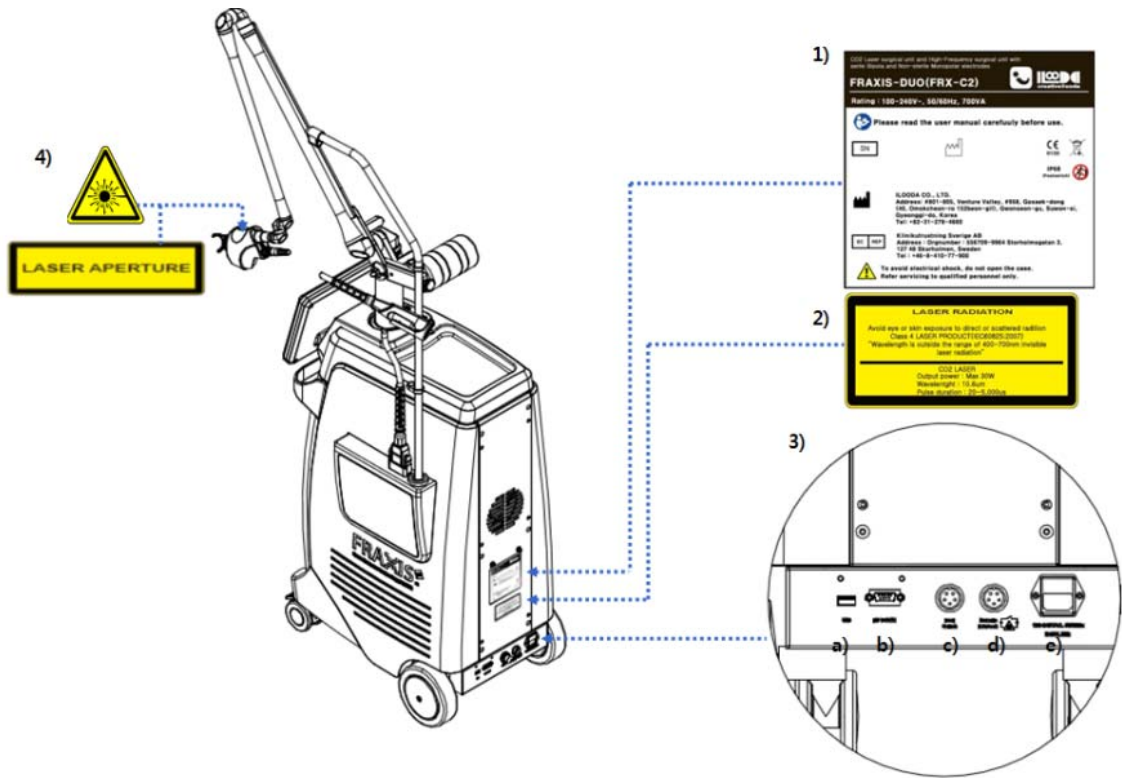





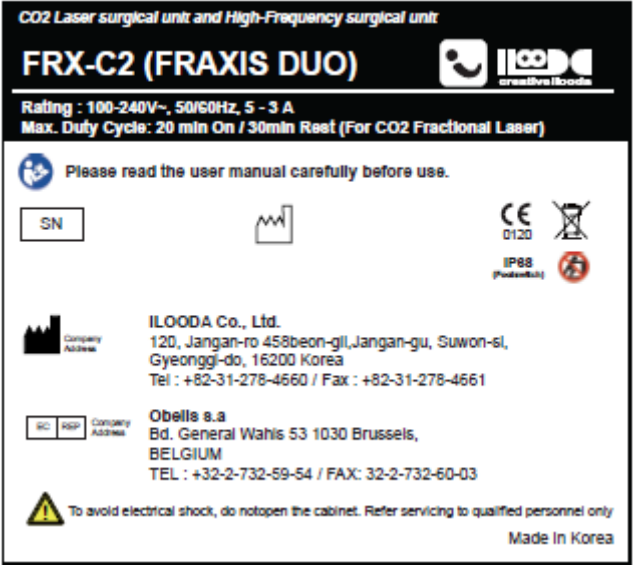

No	Indication	Type	Description
1		LABEL	This label is attached on the right of front side of body (next to emergency button) and indicates immediate stop of operation in emerge
2		Symbol	Power on/off
3		LABLE	Power on-off warning label

- Rear





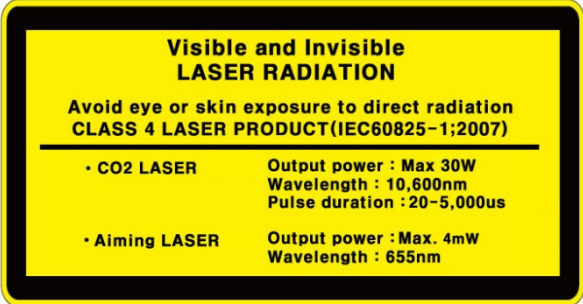

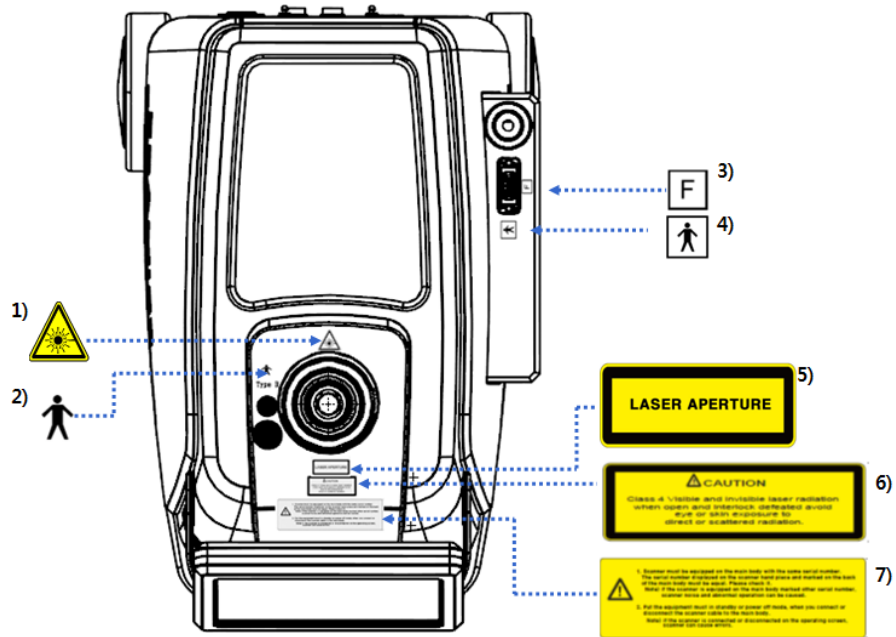

1)	Attachment 1	LABEL	General product information
2)	Attachment 1	LABEL	Laser specification and safety information
3)	a) USB Port	Text printing	Program update connector
	b) ISP Terminal	Text printing	Program update connector
	c) Foot switch	Text printing	Footswitch connector
	d) 	Text printing Symbol	Remote interlock connector
	e) 100-240V~, 50/60Hz	Text printing	Input power
	250V, T5.0 AH	Symbol	Fuse power
4)		LABEL	Laser safety label
			

* Attachment 1

Indication		Content
		User Manual Reference
		Serial No
		Manufacture Date
		Manufacturer
		CE(MDD) Marking
		Waste Electrical and Electronic Equipment
		Pushing Prohibited
		Warning marking
		Indicates the equipment is categorized as Class 4 laser product(According to the IEC60825-1;2007)

- Top



No	Description		
1)		LABEL	Laser emitting a warning when removing the cover
2)		Symbol	Patient applied part about Laser treatment part.
3)		Symbol	Bipolar isolated from earth at High-frequency.
4)		Symbol	Patient applied part about High-frequency treatment part.
5)		LABEL	Laser safety label
6)		LABEL	Laser emitting a warning
7)	Attachment 2.	LABEL	Caution for Scanner handpiece

- Attachment 2.

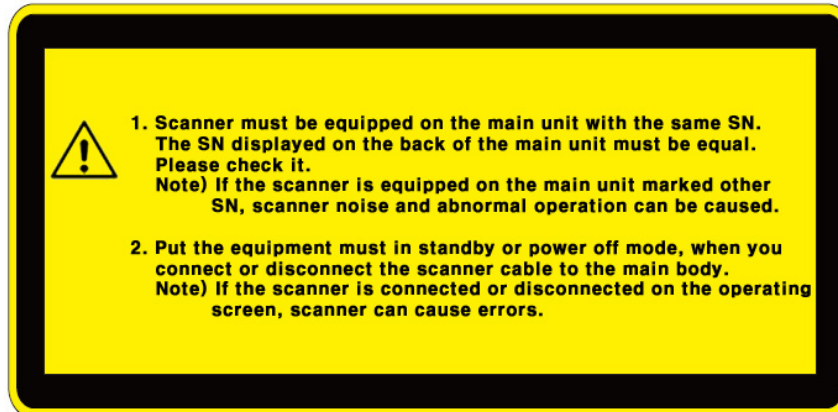









































2) Accessory

- HF electrosurgical electrode(Needle Tip)

No		Symbol	Description
1-b			Manufacturing date
			Lot number
			Use by date (Expiration date)
			Sterile using EO gas
			Consult User manual
			Single use
			Don't use when packing damaged
			Keep away from sunlight
			Storage temperature limitation
			Manufacturer
			Authorized EC representative

- Handpieces

HF treatment part_ Bipolar handpiece	
<p>Bipolar H/P</p> <p> Please read the user manual carefully before use.</p> <p> SN   </p> <p> Make sure to install and use the main unit and accessories.</p>	<p> ILOODA Co., Ltd. Address: 120, Jangan-ro 458beon-gil, Jangan-gu, Suwon-si, Gyeonggi-do, 16200 Korea Tel : +82-31-278-4660 / Fax : +82-31-278-4661</p> <p> Obelic s.a Address: Bd. General Wauts 53 1030 Brussels, BELGIUM TEL : +32-2-732-59-54 / FAX: 32-2-732-60-03</p>
Laser treatment part_ Scanner /Normal Handpiece	
<p>Smart Surgi H/P</p> <p> Please read the user manual carefully before use.</p> <p> SN   </p> <p> Make sure to install and use the main unit and accessories.</p>	<p> ILOODA Co., Ltd. Address: 120, Jangan-ro 458beon-gil, Jangan-gu, Suwon-si, Gyeonggi-do, 16200 Korea Tel : +82-31-278-4660 / Fax : +82-31-278-4661</p> <p> Obelic s.a Address: Bd. General Wauts 53 1030 Brussels, BELGIUM TEL : +32-2-732-59-54 / FAX: 32-2-732-60-03</p>
<p>CO2 scanner H/P</p> <p> Please read the user manual carefully before use.</p> <p> SN   </p> <p> Make sure to install and use the main unit and accessories.</p>	<p> ILOODA Co., Ltd. Address: 120, Jangan-ro 458beon-gil, Jangan-gu, Suwon-si, Gyeonggi-do, 16200 Korea Tel : +82-31-278-4660 / Fax : +82-31-278-4661</p> <p> Obelic s.a Address: Bd. General Wauts 53 1030 Brussels, BELGIUM TEL : +32-2-732-59-54 / FAX: 32-2-732-60-03</p>
<p>Gyno H/P</p> <p> Please read the user manual carefully before use.</p> <p> SN   </p> <p> Make sure to install and use the main unit and accessories.</p>	<p> ILOODA Co., Ltd. Address: 120, Jangan-ro 458beon-gil, Jangan-gu, Suwon-si, Gyeonggi-do, 16200 Korea Tel : +82-31-278-4660 / Fax : +82-31-278-4661</p> <p> Obelic s.a Address: Bd. General Wauts 53 1030 Brussels, BELGIUM TEL : +32-2-732-59-54 / FAX: 32-2-732-60-03</p>

Symbol	Description	Symbol	Description
	Manufacturing date		Manufacturer
	Serial No		Authorized EC representative
	Warning marking		CE(MDD) Marking
	User Manual Reference		Waste Electrical and Electronic Equipment

Appendix 2. Regular Safety Inspection

FRAXIS DUO is provided with various safety label and safety devices. For the safety use, do not destroy these devices and keep it safe. According to local regulation, safety checking is practiced annually and have to check all safety functions working properly.

► Equipment safety checking

Refer to the equipment checking list and contact the agent in case of the problem on it, Refer to "Table. daily equipment inspection log"

Object of Inspection	Matters to be Inspected	Result of Inspection YES / NO	Inspector	Remarks
Laser enclosure	Check whether or not laser, main power cable and plug are worn out or damaged.			
Laser labeling	Check whether or not the laser label is properly attached without damage.			
Earthing resistance	Carry out earthing resistance test in accordance with IEC601.			
Short circuit	Carry out short circuit test in accordance with IEC601.			
Insulation	Carry out insulation test in accordance with IEC601.			
Key switch	1. Turn off key switch and check whether or not energy is emitted.			
Foot switch	1. Check if there is any damage on the machine or cable. 2. The energy(laser or HF) is emitted when you press the Foot switch only at READY. When you press foot switch at the STANDBY, check the laser emission or HF output.			
Emergency Stop button	Press emergency stop button in the treatment mode. It is normal only if treatment is discontinued immediately.			
Remote interlock	Check whether or not the equipment properly stops when taking out the remote interlock while in operation. Check if there is any error message when operating equipment without remote interlock. It is normal only if the equipment does not operate with error message.			

▶ RF Block Out System

- Key switch

The equipment is operated only the key switch is on. You can pull out the key only when it is off position. (inspect annually at least in accordance with regular safety inspection regulation)

- Warning of RF radiation

Visual warning on display and audial warning is installed together.

This Warning sign is expressed on LCD and “beep” sound at the same time.

(Inspect annually at least in accordance with regular safety inspection regulation)

- Foot Switch

RF is emitted when the foot switch is pressed.

The error sign is coming and the equipment is not operating when the foot switch is not connected. (Inspect annually at least in accordance with regular safety inspection regulation)

- Cable

Always check the damage of power cable.

Must check the cable before and after use.

Appendix 3. The revision of User manual

REV	Revisions	Date
IFU-E-FRX-02(REV.0)	First Edition of User Manual	18 th .MAR.2014
IFU-E-FRX-C2(REV.1)	Change the contents & Management number	10 th .JUN.2014
IFU-E-FRX-C2(REV.2)	Added to Gyno laser part	28 th NOV 2014
IFU-E-FRX-C2(REV.3)	Changed the AR	15 th DEC 2014
IFU-E-FRX-C2(REV.4)	Additional Notes for Installation	30 th MAR 2015
IFU-E-FRX-C2(REV.5)	Change the Manufacture address	21 th OCT 2015
IFU-E-FRX-C2(REV.6)	Change the Gyno Laser Probe shape	24 th NOV 2015